

AMMC-6650

DC–40 GHz Variable Attenuator

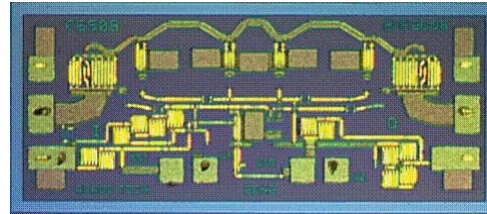

Data Sheet



Chip Size: 1530 μm x 660 μm (61.2 x 26.4 mils)
 Chip Size Tolerance: ± 10 μm (± 0.4 mils)
 Chip Thickness: 100 ± 10 μm (4 ± 0.4 mils)
 Pad Dimensions: 80 x 120 μm (3.2 x 4.8 mils)

Description

The AMMC-6650 is a voltage controlled variable attenuator designed to operate from DC–40 GHz. It is fabricated using Avago Technologies enhancement mode pHEMT MMIC process with backside ground vias, and gate lengths of approximately 0.25 μm . The distributed topology of the AMMC-6650 facilitates broadband operation by absorbing parasitic effects of its series and shunt FETs. An on-chip DC reference circuit may be used to maintain optimum VSWR for any attenuation setting or to provide more linear attenuation versus voltage response.

Simplified Schematic

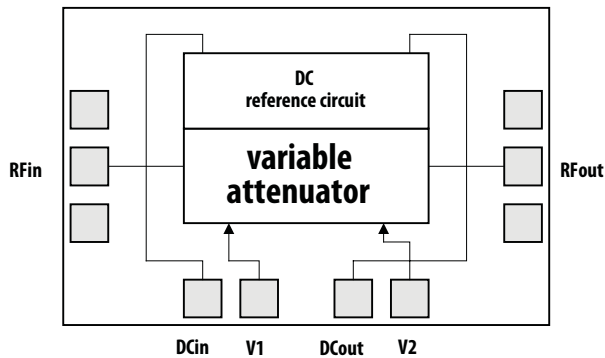

Features

- Wide Frequency Range DC–40 GHz
- Attenuation Range 20dB
- Single Positive Bias Supply
- Unconditionally Stable

Applications

- Microwave Radio Systems
- Satellite VSAT, DBS Up / Down Link
- LMDS & Pt – Pt mmW Long Haul
- Broadband Wireless Access (including 802.16 and 802.20 WiMax)
- WLL and MMDS loops



Attention: Observe precautions for handling electrostatic sensitive devices.
 ESD Machine Model = 80 V
 ESD Human Body Model = 400 V
 Refer to Avago Application Note A004R: Electrostatic Discharge, Damage and Control.

Table 1. Absolute Maximum Ratings

Symbol	Parameters and Test Conditions	Unit	Minimum	Maximum
V ₁	Voltage to Control VSWR	V	0	1.6
V ₂	Voltage to Control Attenuation	V	0	1.6
P _{in}	RF Input Power	dBm	-	17
T _{ch}	Operating Channel Temperature	°C	-	+150
T _{stg}	Storage Temperature	°C	-65	+150
T _{max}	Maximum Assembly Temperature	°C		+300 for 60 seconds

Notes:

Operation in excess of any one of these conditions may result in permanent damage to this device.

The absolute maximum ratings for V₁, V₂ and P_{in} were determined at an ambient temperature of 25°C unless noted otherwise.**Table 2. DC Specifications**

Symbol	Parameters	Test Conditions	Unit	Min	Typical	Max
I _{c_V1_ref}	V ₁ Control Current (Min Attenuation)	V1=1.5 V, V2=0 V	mA	-	1.93	2.0
I _{c_V2_ref}	V ₂ Control Current (Min Attenuation)	V1=1.5 V, V2=0 V	uA	-	0.8	2.5
I _{c_V1_max}	V ₁ Control Current (Max Attenuation)	V1=0V, V2=1.25 V	uA	-	1.1	2.5
I _{c_V2_max}	V ₂ Control Current (Max Attenuation)	V1=0V, V2=1.25 V	mA	-	1.41	1.5

Notes:

Ambient temperature T_A = 25°C**Table 3. RF Specifications (T_A = 25°C, Z₀ = 50 Ω)**

Symbol	Parameters and Test Conditions	Units	Freq. [GHz]	Minimum	Typical	Maximum
Minimum Attenuation (Reference State)	S ₂₁ V1 = 1.5 V V2 = 0.0 V	dB	2		1.1	2.0
			20		1.7	2.5
			33		2.6	4.0
			40		3.1	5.0
Maximum Attenuation	S ₂₁ V1 = 0.0 V V2 = 1.25 V	dB	2	24.0	26.4	
			20	24.5	28.1	
			33	26.0	32.7	
			40	27.0	35.7	
Return Loss (In/Out) at Reference State	V1=1.5 V, V2=0.0 V	dB	<40		10	
Return Loss (In/Out) at Max. Attenuation	V1=0.0 V, V2=1.25 V	dB	<40		10	

Notes:

Data obtained from on-wafer measurements

Typical Distribution Charts

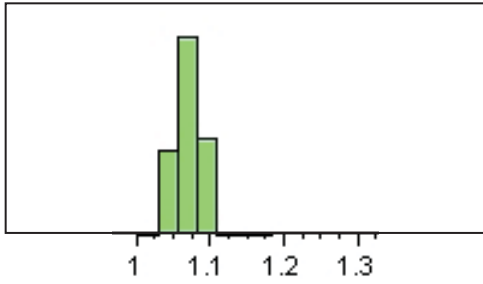

Figure 1d. Min Attenuation @ 2GHz, Nominal=1.1, USL=2.0

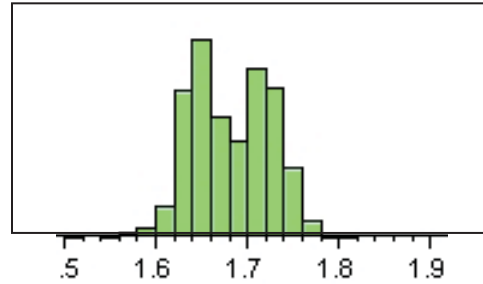

Figure 2d. Min Attenuation @ 20GHz, Nominal=1.7, USL=2.5

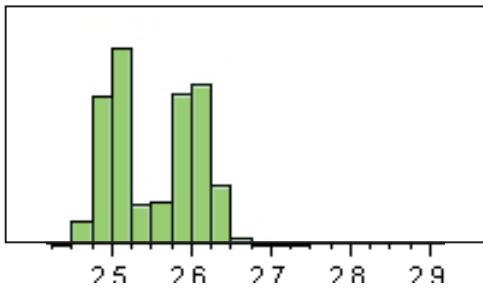

Figure 3d. Min Attenuation @ 33GHz, Nominal=2.6, USL=4.0

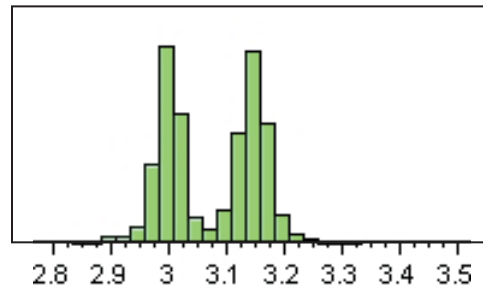

Figure 4d. Min Attenuation @ 40GHz, Nominal=3.1, USL=5.0

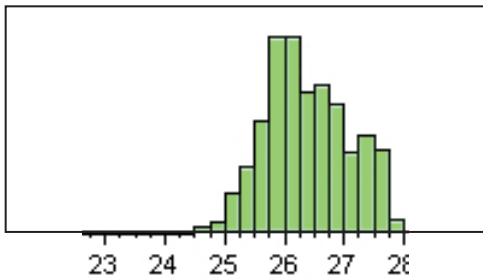

Figure 5d. Max Attenuation @ 2GHz, LSL=24.0, Nominal=26.4

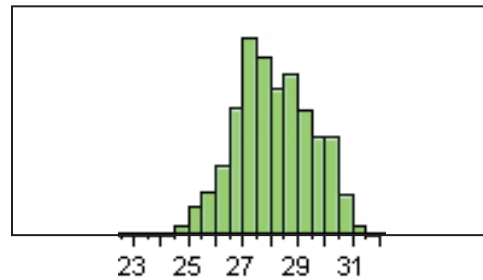

Figure 6d. Max Attenuation @ 20GHz, LSL=24.5, Nominal=24.5

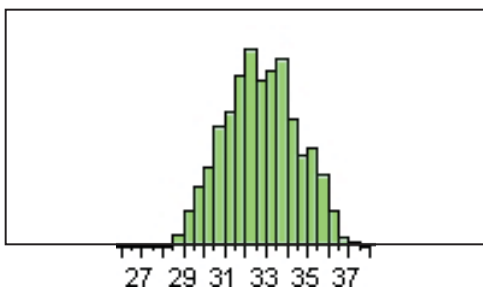

Figure 7d. Max Attenuation @ 33GHz, LSL=26.0, Nominal=32.7

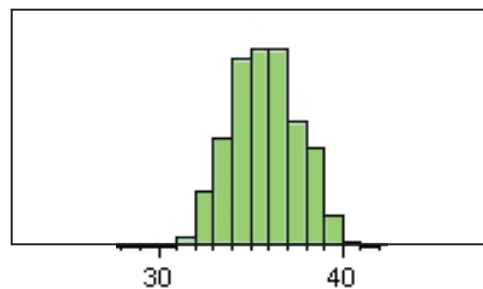

Figure 8d. Max Attenuation @ 40GHz, LSL=27.0, Nominal=35.7

Notes:

1. All data from on-wafer measurements
2. Distribution data based on 5000 part sample from two wafer lots tested during initial characterization. Future wafers may have nominal values anywhere between upper and lower limit

Typical Performance ($T_A = 25^\circ\text{C}$, $Z_{in} = Z_{out} = 50 \Omega$)

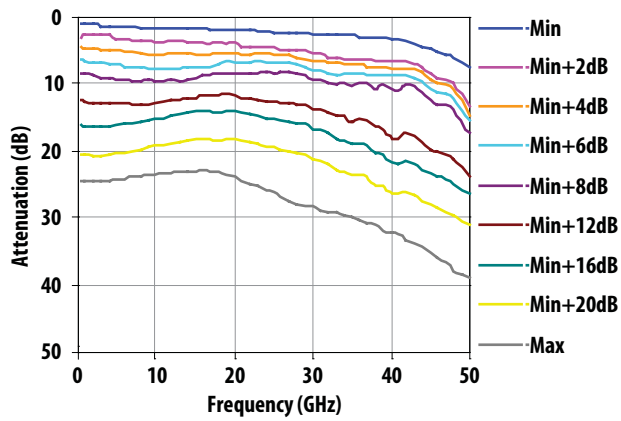

Figure 1. Attenuation vs Frequency

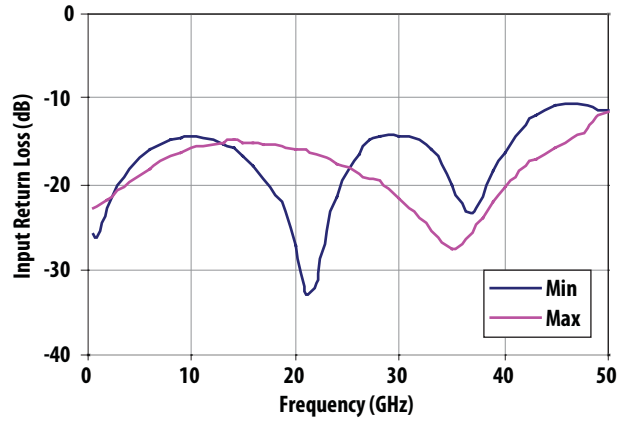

Figure 2. Input Return Loss vs Frequency

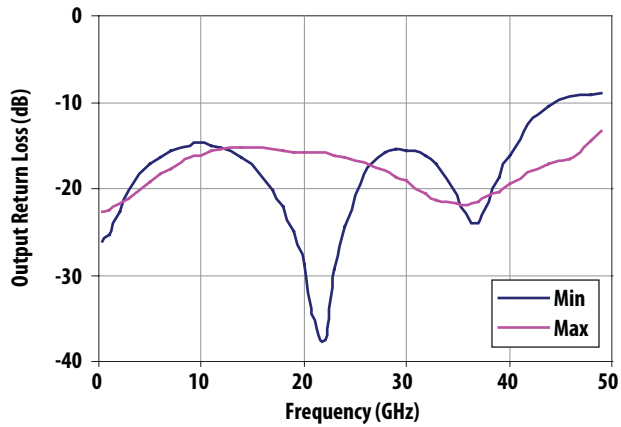

Figure 3. Output Return Loss vs Frequency

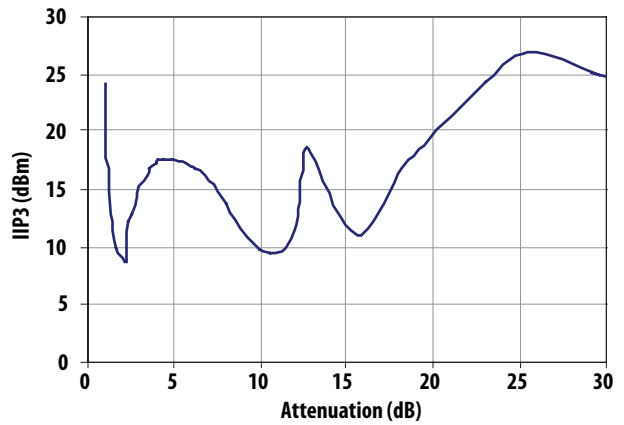

Figure 4. IIP3 vs Attenuation at 2 GHz (note 2)

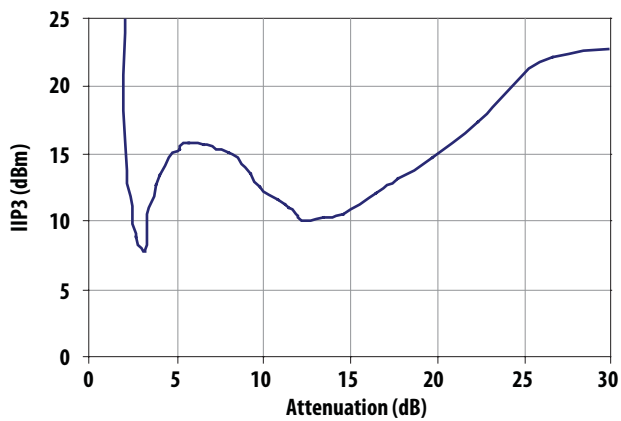

Figure 5. IIP3 vs Attenuation at 12 GHz (note 2)

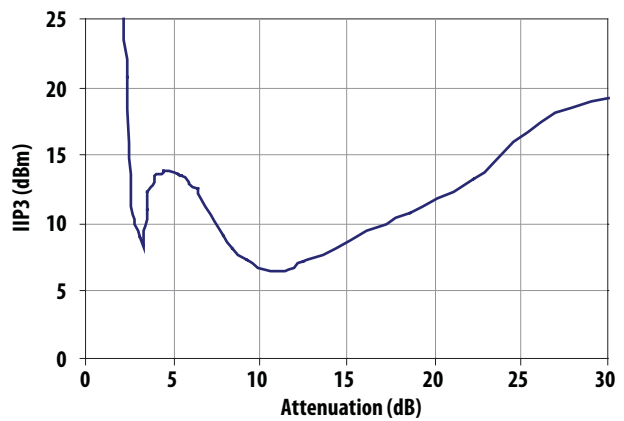

Figure 6. IIP3 vs Attenuation at 22 GHz (note 2)

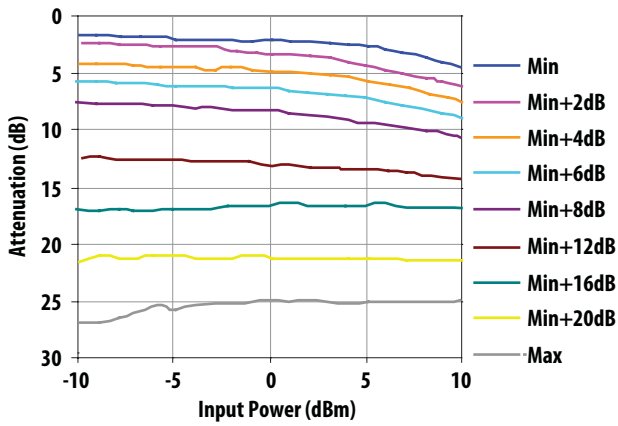

Figure 7. Attenuation vs Input Power at 2 GHz

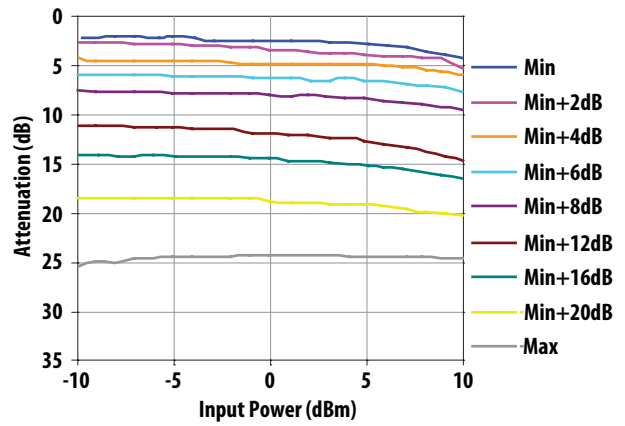

Figure 8. Attenuation vs Input Power at 12 GHz

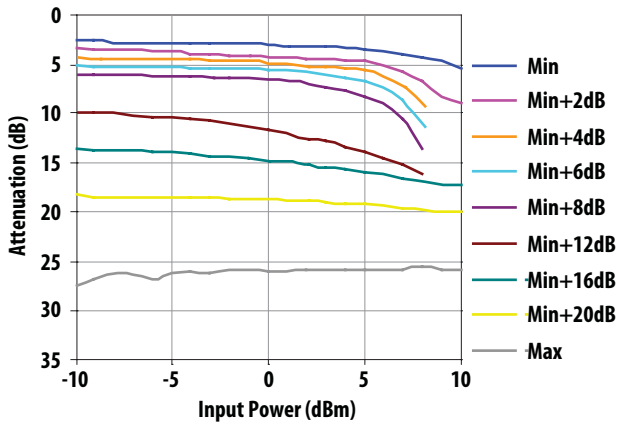

Figure 9. Attenuation vs Input Power at 22 GHz

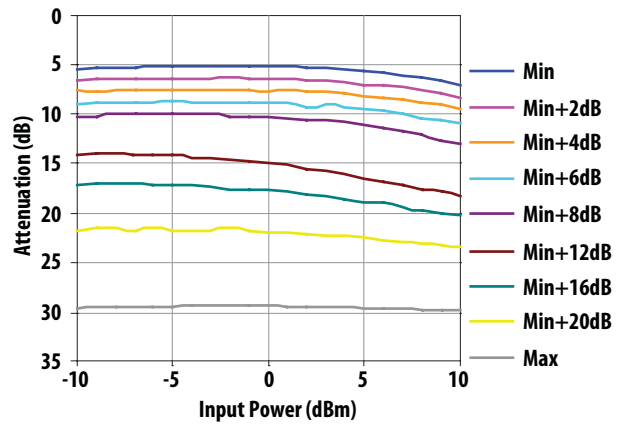

Figure 10. Attenuation vs Input Power at 32 GHz

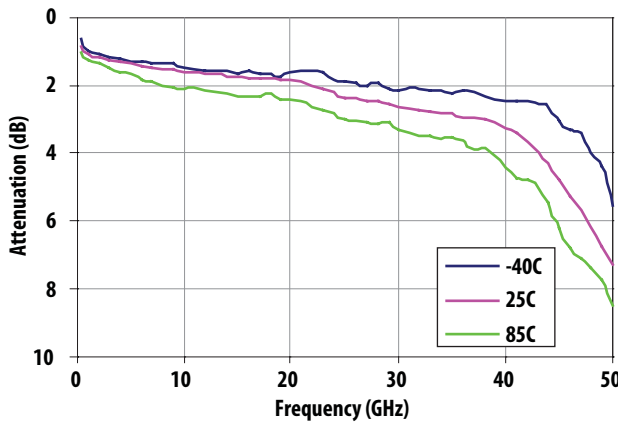

Figure 11. Attenuation vs Frequency (Min Attenuation)

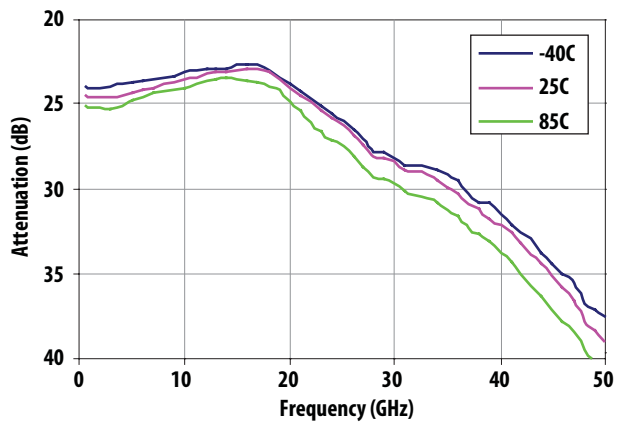

Figure 12. Attenuation vs Frequency (Max Attenuation)

Notes:

1. All tests done on a AMMC-6650 mounted on a PCB equipped with RF connectors and an op-amp driver shown in Figure 14.
2. IIP3 measured with two input signals with frequency difference of 10 MHz, each input signal at -10 dBm
3. All attenuation settings were done at 2GHz

**AMMC-6650 Typical Scattering Parameters at Minimum Attenuation
(Measured on-wafer, Tc = 25°C, Zo = 50ohm, V1 = 1.5V, V2 = 0V)**

Freq GHz	S11			S21			S12			S22		
	dB	Mag	Phase	dB	Mag	Phase	dB	Mag	Phase	dB	Mag	Phase
0.5	-25.969	0.050	-39.087	-1.135	0.878	-5.786	-1.147	0.876	-5.788	-26.143	0.049	-39.150
1.0	-26.108	0.050	-66.653	-1.103	0.881	-10.300	-1.176	0.873	-10.283	-25.498	0.053	-60.168
2.0	-22.757	0.073	-93.483	-1.132	0.878	-19.219	-1.230	0.868	-19.238	-22.662	0.074	-85.472
3.0	-20.131	0.099	-108.015	-1.242	0.867	-28.116	-1.341	0.857	-28.094	-20.202	0.098	-102.098
4.0	-18.373	0.121	-120.271	-1.313	0.860	-36.932	-1.428	0.848	-36.892	-18.533	0.118	-115.389
5.0	-16.948	0.142	-131.540	-1.359	0.855	-45.539	-1.470	0.844	-45.485	-17.310	0.136	-127.577
6.0	-16.016	0.158	-140.873	-1.420	0.849	-54.184	-1.544	0.837	-53.995	-16.346	0.152	-137.375
7.0	-15.340	0.171	-149.734	-1.464	0.845	-62.729	-1.595	0.832	-62.548	-15.740	0.163	-146.531
8.0	-14.813	0.182	-157.525	-1.522	0.839	-71.279	-1.653	0.827	-71.025	-15.254	0.173	-155.038
9.0	-14.689	0.184	-165.279	-1.551	0.837	-79.808	-1.702	0.822	-79.509	-15.026	0.177	-163.282
10.0	-14.466	0.189	-172.907	-1.616	0.830	-88.399	-1.746	0.818	-88.014	-14.943	0.179	-171.767
11.0	-14.737	0.183	-179.967	-1.643	0.828	-96.805	-1.788	0.814	-96.516	-15.006	0.178	179.931
12.0	-14.851	0.181	172.450	-1.678	0.824	-105.447	-1.819	0.811	-105.110	-15.360	0.171	172.348
13.0	-15.386	0.170	165.587	-1.699	0.822	-114.080	-1.838	0.809	-113.678	-15.831	0.162	164.283
14.0	-15.918	0.160	158.241	-1.733	0.819	-122.788	-1.850	0.808	-122.395	-16.415	0.151	156.596
15.0	-16.809	0.144	151.016	-1.753	0.817	-131.503	-1.870	0.806	-131.171	-17.355	0.136	148.580
16.0	-17.890	0.128	143.458	-1.781	0.815	-140.327	-1.889	0.805	-139.898	-18.621	0.117	141.079
17.0	-19.372	0.108	135.142	-1.801	0.813	-149.250	-1.896	0.804	-148.860	-20.175	0.098	134.038
18.0	-21.140	0.088	127.266	-1.806	0.812	-158.422	-1.917	0.802	-158.009	-22.192	0.078	125.365
19.0	-23.388	0.068	116.287	-1.836	0.810	-167.679	-1.934	0.800	-167.132	-24.928	0.057	118.442
20.0	-27.432	0.043	99.261	-1.867	0.807	-176.938	-1.961	0.798	-176.522	-28.730	0.037	107.600
21.0	-32.956	0.023	59.397	-1.920	0.802	173.528	-2.023	0.792	174.005	-35.239	0.017	81.055
22.0	-31.568	0.026	-19.082	-2.000	0.794	163.905	-2.096	0.786	164.364	-37.589	0.013	-23.760
23.0	-25.613	0.052	-53.962	-2.121	0.783	154.170	-2.209	0.775	154.655	-29.473	0.034	-61.826
24.0	-21.577	0.083	-71.482	-2.230	0.774	144.556	-2.348	0.763	145.178	-24.437	0.060	-73.246
25.0	-18.380	0.121	-85.747	-2.348	0.763	135.424	-2.448	0.754	136.043	-20.896	0.090	-85.749
26.0	-16.461	0.150	-100.632	-2.387	0.760	126.769	-2.498	0.750	127.328	-18.496	0.119	-98.530
27.0	-15.006	0.178	-114.327	-2.450	0.754	118.757	-2.553	0.745	119.173	-16.755	0.145	-110.996
28.0	-14.352	0.192	-127.726	-2.494	0.750	110.138	-2.597	0.742	110.632	-15.885	0.161	-123.634
29.0	-14.239	0.194	-137.892	-2.585	0.743	101.101	-2.638	0.738	101.581	-15.473	0.168	-134.550
30.0	-14.485	0.189	-147.053	-2.649	0.737	91.495	-2.681	0.734	91.910	-15.650	0.165	-144.865
31.0	-14.535	0.188	-155.460	-2.703	0.733	82.323	-2.726	0.731	82.845	-15.735	0.163	-151.713
32.0	-15.001	0.178	-164.229	-2.737	0.730	73.207	-2.773	0.727	73.808	-16.165	0.156	-160.229
33.0	-16.021	0.158	-171.696	-2.784	0.726	63.269	-2.832	0.722	63.902	-17.215	0.138	-168.812
34.0	-17.735	0.130	-177.349	-2.833	0.722	53.098	-2.873	0.718	53.676	-18.854	0.114	-174.738
35.0	-20.087	0.099	-178.011	-2.832	0.722	42.787	-2.922	0.714	43.305	-20.964	0.090	-173.111
36.0	-22.476	0.075	-166.294	-2.949	0.712	31.993	-2.958	0.711	32.694	-23.427	0.067	-162.318
37.0	-23.479	0.067	-143.625	-2.966	0.711	21.034	-3.013	0.707	21.810	-24.082	0.063	-137.349
38.0	-21.463	0.085	-122.928	-3.009	0.707	9.877	-3.088	0.701	10.556	-21.587	0.083	-117.676
39.0	-18.570	0.118	-116.928	-3.119	0.698	-1.475	-3.194	0.692	-0.735	-18.599	0.118	-113.548
40.0	-16.375	0.152	-118.715	-3.243	0.688	-13.001	-3.317	0.683	-12.195	-16.283	0.153	-115.929
41.0	-14.563	0.187	-123.769	-3.424	0.674	-24.858	-3.491	0.669	-24.054	-14.316	0.192	-121.984
42.0	-13.116	0.221	-130.906	-3.690	0.654	-36.766	-3.756	0.649	-36.082	-12.686	0.232	-130.382
43.0	-12.013	0.251	-139.354	-4.013	0.630	-48.669	-4.088	0.625	-48.156	-11.509	0.266	-139.456
44.0	-11.264	0.273	-148.870	-4.342	0.607	-60.453	-4.425	0.601	-59.744	-10.672	0.293	-149.803
45.0	-10.800	0.288	-158.844	-4.784	0.577	-72.706	-4.816	0.574	-71.850	-9.962	0.318	-160.722
46.0	-10.586	0.296	-169.457	-5.259	0.546	-84.156	-5.296	0.544	-83.532	-9.476	0.336	-171.880
47.0	-10.592	0.295	-179.737	-5.672	0.521	-95.670	-5.720	0.518	-95.070	-9.224	0.346	176.644
48.0	-10.779	0.289	170.426	-6.145	0.493	-107.654	-6.224	0.488	-107.004	-9.136	0.349	164.963
49.0	-11.283	0.273	162.115	-6.762	0.459	-119.116	-6.798	0.457	-118.459	-9.000	0.355	152.822

AMMC-6650 Typical Scattering Parameters at Maximum Attenuation
(Measured on-wafer, Tc = 25°C, Zo = 50ohm, V1 = 0V, V2 = 1.25V)

Freq GHz	S11			S21			S12			S22		
	dB	Mag	Phase	dB	Mag	Phase	dB	Mag	Phase	dB	Mag	Phase
0.5	-22.853	0.072	-12.256	-24.466	0.060	-3.791	-24.539	0.059	-3.663	-22.627	0.074	-12.664
1.0	-22.534	0.075	-21.574	-24.510	0.060	-6.688	-24.568	0.059	-6.693	-22.545	0.075	-21.431
2.0	-21.906	0.080	-38.524	-24.539	0.059	-12.555	-24.524	0.059	-12.714	-21.895	0.080	-38.026
3.0	-20.867	0.091	-53.432	-24.510	0.060	-18.549	-24.481	0.060	-18.529	-21.042	0.089	-53.608
4.0	-19.862	0.102	-66.954	-24.451	0.060	-24.608	-24.451	0.060	-24.729	-20.140	0.098	-66.814
5.0	-19.023	0.112	-78.640	-24.308	0.061	-30.768	-24.351	0.061	-30.758	-19.228	0.109	-78.878
6.0	-18.209	0.123	-89.031	-24.166	0.062	-37.148	-24.194	0.062	-37.219	-18.387	0.120	-89.054
7.0	-17.445	0.134	-98.870	-24.013	0.063	-44.026	-23.986	0.063	-43.803	-17.661	0.131	-98.201
8.0	-16.803	0.145	-107.012	-23.849	0.064	-51.085	-23.822	0.064	-50.879	-17.046	0.141	-106.952
9.0	-16.346	0.152	-114.618	-23.688	0.065	-58.509	-23.675	0.066	-58.452	-16.496	0.150	-114.984
10.0	-15.890	0.161	-121.500	-23.531	0.067	-66.183	-23.531	0.067	-66.106	-16.110	0.157	-122.545
11.0	-15.494	0.168	-127.928	-23.375	0.068	-74.133	-23.363	0.068	-74.120	-15.751	0.163	-129.664
12.0	-15.315	0.172	-134.558	-23.248	0.069	-82.421	-23.210	0.069	-82.298	-15.509	0.168	-136.450
13.0	-15.169	0.174	-140.662	-23.135	0.070	-91.000	-23.073	0.070	-90.910	-15.340	0.171	-142.742
14.0	-15.011	0.178	-146.591	-23.061	0.070	-100.015	-23.012	0.071	-99.961	-15.274	0.172	-149.243
15.0	-15.045	0.177	-151.665	-22.987	0.071	-109.481	-22.963	0.071	-109.601	-15.264	0.173	-154.910
16.0	-15.209	0.174	-156.830	-22.902	0.072	-119.366	-22.914	0.072	-119.416	-15.371	0.170	-160.368
17.0	-15.325	0.171	-162.011	-22.950	0.071	-130.119	-22.902	0.072	-130.079	-15.540	0.167	-165.316
18.0	-15.453	0.169	-166.083	-23.135	0.070	-141.644	-23.073	0.070	-141.663	-15.783	0.163	-169.305
19.0	-15.708	0.164	-170.398	-23.544	0.067	-153.417	-23.453	0.067	-153.207	-15.928	0.160	-172.863
20.0	-15.972	0.159	-174.733	-24.027	0.063	-164.758	-23.849	0.064	-164.846	-15.890	0.161	-176.478
21.0	-16.143	0.156	-178.859	-24.423	0.060	-174.164	-24.408	0.060	-174.163	-15.896	0.160	-178.673
22.0	-16.472	0.150	-176.398	-24.913	0.057	-178.184	-24.852	0.057	-178.157	-16.027	0.158	-173.400
23.0	-16.973	0.142	-170.743	-25.368	0.054	-172.250	-25.272	0.055	-172.286	-16.160	0.156	-167.414
24.0	-17.530	0.133	-166.527	-25.849	0.051	-167.104	-25.730	0.052	-166.986	-16.478	0.150	-161.938
25.0	-18.041	0.125	-164.230	-26.214	0.049	-164.229	-26.249	0.049	-163.911	-16.839	0.144	-156.076
26.0	-18.651	0.117	-159.564	-26.840	0.046	-159.223	-27.111	0.044	-159.007	-17.171	0.139	-149.903
27.0	-19.356	0.108	-154.880	-27.351	0.043	-153.963	-27.556	0.042	-153.449	-17.582	0.132	-143.328
28.0	-19.676	0.104	-149.943	-28.046	0.040	-146.145	-27.766	0.041	-145.705	-17.951	0.127	-136.221
29.0	-20.537	0.094	-144.531	-28.179	0.039	-137.226	-28.134	0.039	-137.096	-18.540	0.118	-128.334
30.0	-21.650	0.083	-135.232	-28.382	0.038	-127.342	-28.382	0.038	-126.543	-19.188	0.110	-118.732
31.0	-22.793	0.073	-126.384	-28.898	0.036	-120.275	-28.826	0.036	-120.255	-20.035	0.100	-109.204
32.0	-24.013	0.063	-118.078	-28.995	0.036	-112.761	-28.947	0.036	-112.587	-20.612	0.093	-99.496
33.0	-25.482	0.053	-103.602	-29.168	0.035	-103.999	-29.143	0.035	-103.186	-21.300	0.086	-86.280
34.0	-26.916	0.045	-81.551	-29.551	0.033	-95.536	-29.499	0.034	-95.099	-21.598	0.083	-71.770
35.0	-27.639	0.042	-58.000	-29.924	0.032	-86.633	-29.924	0.032	-86.302	-21.820	0.081	-57.472
36.0	-27.171	0.044	-33.749	-30.257	0.031	-77.849	-30.286	0.031	-76.950	-21.982	0.080	-41.425
37.0	-25.866	0.051	-12.352	-30.842	0.029	-69.338	-30.663	0.029	-70.386	-21.660	0.083	-26.238
38.0	-23.917	0.064	-1.642	-31.150	0.028	-61.281	-31.437	0.027	-59.108	-20.983	0.089	-12.205
39.0	-22.114	0.078	-15.994	-31.768	0.026	-53.207	-31.835	0.026	-53.814	-20.436	0.095	0.368
40.0	-20.391	0.096	-25.159	-32.146	0.025	-45.630	-32.146	0.025	-43.354	-19.643	0.104	-11.716
41.0	-19.220	0.109	-32.093	-32.542	0.024	-36.224	-32.653	0.023	-34.798	-18.771	0.115	-21.615
42.0	-17.951	0.127	-40.338	-33.191	0.022	-27.538	-33.231	0.022	-27.350	-18.223	0.123	-29.792
43.0	-17.133	0.139	-46.939	-33.893	0.020	-18.674	-33.723	0.021	-17.243	-17.835	0.128	-37.995
44.0	-16.397	0.151	-52.696	-34.379	0.019	-10.281	-34.379	0.019	-11.852	-17.278	0.137	-44.159
45.0	-15.762	0.163	-56.989	-35.090	0.018	-0.062	-35.289	0.017	-2.928	-16.905	0.143	-47.672
46.0	-15.045	0.177	-58.021	-35.863	0.016	-10.034	-35.972	0.016	-7.633	-16.671	0.147	-49.016
47.0	-14.289	0.193	-58.820	-36.595	0.015	-19.609	-36.536	0.015	-18.594	-15.923	0.160	-49.905
48.0	-13.457	0.212	-62.285	-37.856	0.013	-29.064	-37.458	0.013	-28.775	-14.685	0.184	-51.045
49.0	-12.027	0.250	-67.461	-38.344	0.012	-41.406	-37.924	0.013	-37.826	-13.568	0.210	-54.396

Biasing considerations

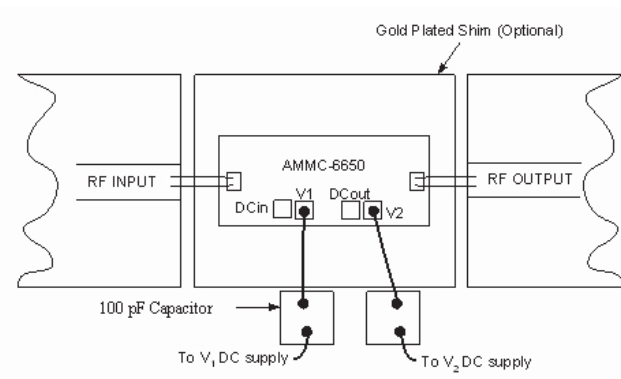

Figure 13. Bias voltage connections

Attenuation is controlled by applying voltage to pins V1 and V2 as shown in Figure 13.

For the minimum attenuation, V1 is set to 1.5 V and V2 is set to 0 V. The 1.5 V applied to the V1 pin biases the series FETs to a full “on” state, while the 0 V applied to the V2 pin keeps the shunt FETs in an “off” or “open” state; thus creating the lumped element 50Ω transmission line effect. The V2 voltage swing from 0 V to 1.25 V increases the level of attenuation. The V1 voltage swing from 1.5 V to 0 V effectively optimizes the input and output match at higher attenuation levels. The AMMC-6650 can be driven by two complementary voltage ramps placed on V1 and V2. Careful adjustment of the two control lines over a relatively small voltage ranges are required to set the attenuation and optimize VSWR.

The on-chip DC reference circuit can be used to optimize VSWR for any attenuation setting, improve voltage versus attenuation linearity and range, and provide temperature compensation.

The on-chip DC reference circuit is a non-distributed “T” attenuator designed to operate in a 500Ω system and track the control voltage versus attenuation characteristics of the RF attenuator. A simplified schematic of the AMMC-6650 together with an op-amp driver that utilizes the DC reference circuit is shown in Figure 14.

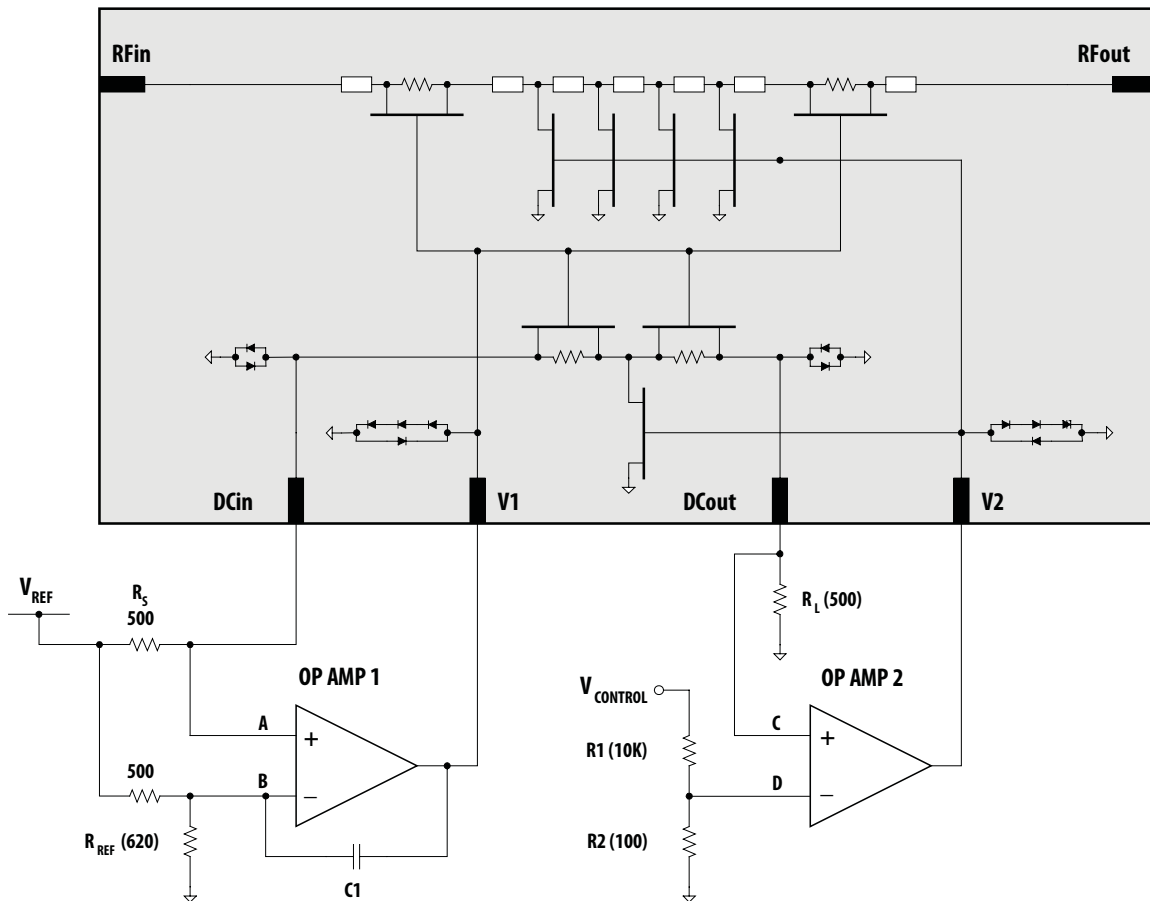

Figure 14. AMMC-6650 and the op-amp driver circuit

OP AMP 1 insures that the attenuator maintains a good input and output match to 50Ω, while **OP AMP 2** increases the usable control voltage range versus using only direct voltage ramps for V1 and V2 and improves over temperature operation.

If optimum VSWR is all that is required, **OP AMP 2** may be eliminated however, R_L must remain connected to the DCout

pad of the AMMC-6650 and the control voltage can be applied directly to V2.

CAUTION: Low voltage op-amps must be used so as not to exceed the maximum limit of V1 and V2 control voltages.

As shown, a voltage reference (V_{REF}) is fed to the reference circuit DCin pad via a 500Ω resistor, creating a 500Ω source. The reference circuit termination R_L, is connected to the DCout pad and ideally is also equal to 500Ω. This voltage is controlled in parallel with the RF attenuator. The chosen value of V_{REF} must be low enough to avoid modifying the FET biasing and lower than the turn-on voltage of the ESD protection diode but high enough such that the attenuated voltage at **OP AMP 2** is usable compared to input offsets etc. The optimum value for the positive reference voltage is approximately 0.1 to 0.4 V.

At equilibrium, the voltages at nodes A and B of the **OPAMP 1** must be equal which implies that the input impedance to the DC reference circuit is equal to R_{REF}. When V2 is changed to a lower value, the voltage at node A becomes greater than that of node B. This voltage difference causes the output voltage of op **OP AMP 1** to move toward its positive rail until equilibrium is once again established. When V2 is changed to a higher value the voltage at node A becomes less than that of node B and the output voltage of **OP AMP 1** will swing toward its negative rail until equilibrium is reached. If the reference circuit precisely tracks the RF circuit, the voltage output of **OP AMP 1** at equilibrium insures that the RF circuit is matched to 50Ω.

If attenuation linearity is required, **OP AMP 2** is included as shown in Figure 14 and a positive control voltage is applied to V_{CONTROL}.

At equilibrium, voltages at nodes C and D are equal. When V_{CONTROL} is changed, the output of **OP AMP 2** adjusts to a value that forces the voltage at node C to equal the voltage at node D. Therefore, the output voltage of the DC reference circuit is proportional to V_{CONTROL}. The input voltage to the reference circuit is being held constant and the log(V_{CONTROL}) is proportional to the reference circuit attenuation 20log(DCout/DCin).

If the FET parameters of the DC reference circuit track the FET parameters of the RF circuit, the voltage output of the RF circuit is also proportional to the control voltage. This translates to a linear relationship between the attenuation (in dB) and the log(V_{CONTROL}).

Two RF attenuation vs voltage curves corresponding to different values of V_{REF} are shown in Figure 15. These curves were obtained by using the driver circuit shown in Figure 14 and the V_{REF} values 0.1 V and 0.4 V.

Values for R_L, R1 and R2 were 500Ω, 10 kΩ and 100Ω respectively. Control voltage ranged from 4.5 V to 0 V.

Because the FETs in the DC circuit are not identical to those in the RF circuit, the DC circuit does not exactly track the RF circuit. This results in attenuation vs. voltage curves that are not exactly linear.

OP AMP 2 provides temperature compensation by adjusting V2 in such a way as to keep voltage at point C equal to that point D. If the attenuation changes over temperature, voltage at point C tries to change, but is corrected by **OP AMP 2**.

Another way to improve performance of the attenuator driver circuit is to adjust R_L and R_{REF}. If the reference circuit precisely tracked the RF circuit and the ON resistance of the FETs was zero ohms, then R_L and R_{REF} would be exactly 500Ω. Due to the difference in layout structures, the reference circuit does not track the RF circuit precisely. R_L and R_{REF} can be adjusted in order to compensate for these differences. Optimum values of R_L and R_{REF} have been found to be between 500Ω and 650Ω.

For maximum dynamic range on the attenuation control circuit, R_L should be less than R_{REF} by an amount equal to the "ON resistance" of the reference circuit series FETs. The "ON resistance" of the series FETs is about 95Ω total. Therefore, the relationship between R_L and R_{REF} is as follows:

$$R_{REF} = R_L + 95\Omega$$

The voltage divider formed by R1 and R2 can be used to adjust the sensitivity of the attenuator versus control voltage. For the driver circuit shown in Figure 14, maximum attenuation is always achieved by setting V_{CONTROL} equal to 0 V. Minimum attenuation is achieved when

$$V_{control} \approx \left(\frac{R1 + R2}{R2} \right) \times \left(\frac{R_L}{500\Omega + R_L} \right) \times V_{ref}$$

or

$$V_{control} \approx \left(1 + \frac{R1}{R2} \right) \times DC_{out}$$

Therefore, an increase in the resistor ratio R1/R2 increases the value of the control voltage required to produce minimum attenuation.

LMV932 (National Semiconductor) was used in the control circuit that produced the results shown in Figure 15; however, any low noise, low offset voltage op amp should produce similar results. LMV932's low supply voltage of 1.8 volts, limits the possibility of exceeding the 1.5 volt absolute maximum of the AMMC-6650 V1 and V2 control line inputs.

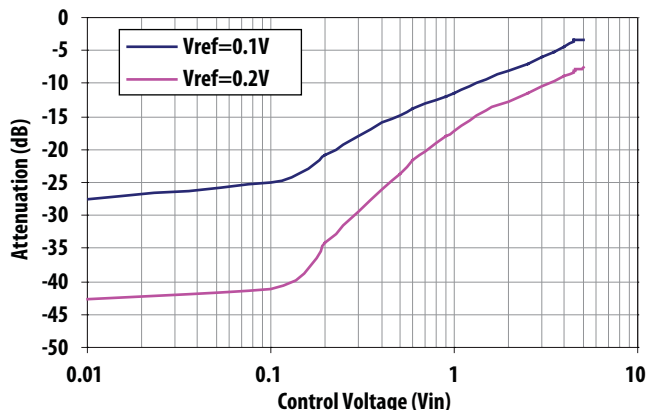

Figure 15. Attenuation vs. Control Voltage, Frequency = 15 GHz

Assembly Techniques

The backside of the MMIC chip is RF ground. The chip should be attached directly to the ground plane (e.g. circuit carrier or heatsink) using electrically conductive epoxy [1,2].

For best performance, the topside of the MMIC should be brought up to the same height as the circuits surrounding it. This can be accomplished by mounting a gold plated metal shim (same length as the MMIC) under the chip. The amount of epoxy used for the chip or shim attachment should be just enough to provide a thin fillet around the bottom perimeter of the chip. The ground plane should be free of any residue that may jeopardize electrical or mechanical contact with the chip.

Part Number Ordering Information

Part Number	Devices Per Container	Container
AMMC-6650-W10	10	Gelpak
AMMC-6650-W50	50	Gelpak

RF connections should be kept as short as reasonable to minimize performance degradation due to undesirable series inductance.

A single bond wire is normally sufficient for signal connections, however double bonding with 0.7mil gold wire will reduce series inductance. Gold thermo-sonic wedge bonding is the preferred method for wire attachment to the bond pads. The recommended wire bond stage temperature is 150°C +/- 2°C. Caution should be taken to not exceed the Absolute Maximum Rating for assembly temperature and time.

The chip is 100um thick and should be handled with care. The MMIC has air bridges on the top surface and should be carefully handled by the edges or with a custom collet, (do not pick up the die with a vacuum on die center). Bonding pads and chip backside metallization are gold.

This MMIC is also static sensitive and ESD precautions should be taken.

Notes:

1. Ablebond 84-1 LMI silver epoxy is recommended
2. Eutectic attach is not recommended and may jeopardize reliability of the device.

Bond Pad Dimensions and Locations

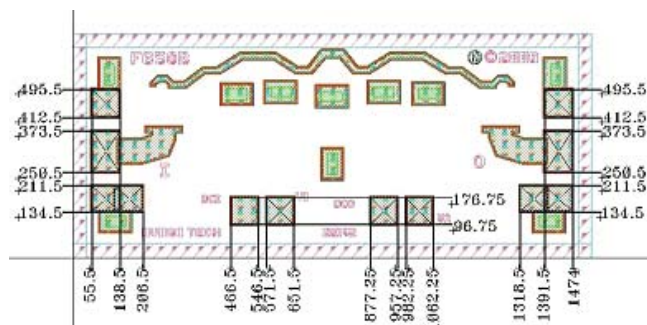

For product information and a complete list of distributors, please go to our web site: www.avagotech.com

Avago, Avago Technologies, and the A logo are trademarks of Avago Technologies in the United States and other countries. Data subject to change. Copyright © 2005-2008 Avago Technologies. All rights reserved. AV02-1301EN - July 11, 2008

AVAGO
TECHNOLOGIES