



Wearable Development Kit User Manual



ON Semiconductor®



Table of contents:

TABLE OF FIGURES:	4
1 INTRODUCTION	6
2 GETTING STARTED	6
2.1 PACKAGE CONTENTS	6
2.2 HIGHLIGHTED FEATURES OF THE WEARABLE DEVELOPMENT KIT	7
2.3 SMART WATCH.....	8
2.4 DOCK STATION MODEL	9
2.5 APPLICATION DOWNLOAD.....	12
3 CHARGING	12
3.1 WIRED CHARGING	12
4 PROGRAMMING/DEBUGGING	13
4.1 SMART WATCH.....	13
4.2 EXPANSION CARD.....	14
4.2.1 <i>Expansion Connector</i>	15
4.2.2 <i>Expansion Card Details</i>	17
4.3 DOCKING STATION NRF52_BLE CHIP	18
5 FEATURES AND SETTINGS	19
5.1 LIST OF ICONS.....	19
5.2 SCREEN BUTTONS.....	19
5.3 SYSTEM CONTROL	20
5.3.1 <i>Power ON/OFF</i>	20
5.3.2 <i>Battery Status</i>	20
5.3.3 <i>Low Battery/Critical Low Battery</i>	20
5.3.4 <i>Screen Lock</i>	21
5.3.5 <i>Auto-Sleep</i>	21
5.3.6 <i>Wake On Motion</i>	21
5.4 BLE CONTROL	22
5.4.1 <i>Turn ON BLE</i>	22
5.4.2 <i>BLE Advertisement</i>	22
5.4.3 <i>Turn OFF BLE</i>	22
5.4.4 <i>Connect/Disconnect with Smart Phone</i>	23
5.5 IN-BUILT UTILITIES.....	24
5.5.1 <i>Clock Selection</i>	24
5.5.2 <i>Time Settings</i>	24
5.5.3 <i>Timer</i>	25
5.5.4 <i>Stopwatch</i>	25
5.5.5 <i>Alerts</i>	25
5.6 CONFIGURATIONS FROM SMART PHONE APPLICATION.....	25
5.6.1 <i>BLE Name Update</i>	26
5.6.2 <i>Haptic Feedback</i>	26
5.6.3 <i>Motion Sensor Data</i>	26
5.6.4 <i>Brightness Settings</i>	26
5.6.5 <i>Clock Settings</i>	26
5.7 DISPLAY NOTIFICATIONS	27
5.7.1 <i>Connect to a Smart Phone</i>	27
5.7.2 <i>Disconnect from Smart Phone</i>	27



Wearable Development Kit User Manual

5.7.3	<i>Fitness Goal Notification</i>	27
5.7.4	<i>Call Notification</i>	27
5.7.5	<i>SMS Notification</i>	28
5.7.6	<i>Alarm Notification</i>	28
5.7.7	<i>Download Notification</i>	28
6	ANDROID MOBILE APPLICATION	28
6.1	SUPPORTED DEVICES.....	28
6.2	APPLICATION OVERVIEW.....	28
6.3	LIST OF FEATURES.....	29
6.3.1	<i>Installation</i>	29
6.3.2	<i>Splash Screen</i>	31
6.3.3	<i>Enabling the Permission for Notification</i>	31
6.3.4	<i>Initial Watch Connect Screen</i>	33
6.3.5	<i>Guidelines Screen</i>	34
6.3.6	<i>Turning ON the Bluetooth Device</i>	35
6.3.7	<i>List of Nearby BLE Devices</i>	36
6.3.8	<i>History Screen</i>	39
6.4	CONFIGURATION SETTINGS.....	46
6.4.1	<i>Smart Watch name</i>	46
6.4.2	<i>Motion Sensor</i>	47
6.4.3	<i>Haptic Feedback</i>	50
6.4.4	<i>Clock Type</i>	51
6.4.5	<i>Brightness Level</i>	52
6.4.6	<i>Notification Settings</i>	53
6.4.7	<i>Goal Settings</i>	54
6.4.8	<i>General Information About User</i>	55
6.5	LOW BATTERY WARNING.....	57
6.6	AUTO RECONNECTION.....	58
6.7	SEARCHING FOR A CONNECTION.....	58
7	IOS MOBILE APPLICATION	60
7.1	SUPPORTED DEVICES.....	60
7.2	LIST OF FEATURES.....	60
7.2.1	<i>Splash Screen</i>	60
7.2.2	<i>Enabling Permission for Notification</i>	61
7.2.3	<i>Initial Smart Watch Connect Screen</i>	61
7.2.4	<i>Guideline Screen</i>	62
7.2.5	<i>Turning ON the Bluetooth Device</i>	63
7.2.6	<i>List of Nearby BLE Devices</i>	64
7.2.7	<i>History Screen</i>	66
7.3	CONFIGURATION SETTINGS.....	72
7.3.1	<i>Smart Watch Name</i>	72
7.3.2	<i>Motion Sensor</i>	73
7.3.3	<i>Haptic Feedback</i>	75
7.3.4	<i>Clock type</i>	76
7.3.5	<i>Brightness Level</i>	77
7.3.6	<i>Notification Settings</i>	78
7.3.7	<i>Goal Settings</i>	79
7.3.8	<i>General Information About User</i>	81
7.4	LOW BATTERY WARNING.....	81
7.5	AUTO RECONNECTION.....	82



Table of Figures:

Figure 1: Wearable Development Kit.....	6
Figure2: Model of Smart Watch showing Buttons and LEDs	8
Figure 3: Wired and Wireless Charging Indication	9
Figure4: Model of Docking Station showing Pogo Pins and USB	9
Figure 5: Model of Docking Station showing the Expansion Connector	11
Figure 6:Model of Docking Station showing the Snap Fit Holder	12
Figure 7: Steps for Charging Smart Watch.....	13
Figure 8: Expansion Card Block Diagram.....	14
Figure 9: Expansion Connector Pin 1 Indication.....	15
Figure 10: Programming of Dock Card	17
Figure 11: Probing of Smart Watch Signals	18
Figure 12: ON Semiconductor logo.....	20
Figure 13: Home page with BLE ON	22
Figure 14: Menu Screen with Notification Alerts Enabled.....	25
Figure15: Installation process.....	29
Figure16: Installing option	30
Figure17: Installed apk screen	30
Figure18: Splash screen.....	31
Figure19: Enable the notification permission.....	32
Figure20: Initial Watch Connection Screen.....	33
Figure21: Guidelines Screen.....	34
Figure22: Bluetooth ON Permission Popup	35
Figure23: Available Devices Name.....	36
Figure24: Connect with the selected device	37
Figure25: Connect with the Smart Phone (Delete Bond is in Enabled State).....	38
Figure26: Home Screen	39
Figure27: Menu Screen	40
Figure28: Settings Screen	41
Figure29: About UsScreen	42
Figure30: Disconnected Screen	43
Figure31: Delete bonding	45
Figure32: Checking the Bond State and Disconnecting	46
Figure33: Edit the Watch Name	47
Figure34: Motion Sensor-Enable-Disable	48
Figure35: Reset Button.....	49
Figure36: Resetting the Data	49
Figure37: Haptic Feedback-Enable-Disable	50
Figure38: Clock Type.....	51
Figure39: Brightness Control	52
Figure40: Notification and Fitness Settings Screen.....	53
Figure41: Setting the Goal Value for Steps, Calories, Active Time and Distance	54
Figure42: Goal Notification.....	55
Figure43: Setting Personal Details like Weight, Height and Age.....	56
Figure44: Low BatteryPopup	57
Figure45: Disconnecting and Auto Connecting.....	58
Figure46: Searching for the Bluetooth Connection	59
Figure47: Splash screen.....	60
Figure48: EnableNotificationsPermission	61
Figure49: Initial Smart Watch Connection Screens.....	62
Figure50: Guidelines screen	63
Figure51: Bluetooth ON Permission Popup	64
Figure52: Available Devices Name.....	65
Figure53: Connect with the Selected Device.....	66



Wearable Development Kit User Manual

Figure54: Home Screen	67
Figure55: Menu screen	68
Figure56: Settings screen.....	69
Figure57: About Us Screen	70
Figure58: Permission for disconnecting	71
Figure59: Disconnect screen.....	71
Figure60: Edit the watch name	72
Figure61: Motion Sensor-Enable-Disable	73
Figure62: Reset button.....	74
Figure63: Resetting the data	75
Figure64: Haptic Feedback-Enable-Disable	76
Figure65: Clock type	77
Figure66: Brightness Control	78
Figure67: Notification and Fitness Settings Screen.....	79
Figure68: Setting Goal Value for Steps, Calories, Active Time and Distance	80
Figure69: Goal Achievement.....	80
Figure 70: Setting Personal Details like Weight, Height and Age.....	81
Figure 71: Low Battery Popup	82
Figure72: Disconnecting and Auto Connecting.....	82



1 Introduction

This user manual is focused for the audience who is going to explore and gain the advantage of using Wearable Development Kit to get exposure about the ON Semiconductor Power management, Battery management, Glue Logics, Backlight driver, Haptic driver, Wireless charging solution. This user manual explains the list of features is developed for Wearable Development kit to demonstrate the ON Semiconductor solutions and provided provisions for developer interaction with kit to explore the solution by means practical methodology to get hands on experience.

It is preferred to read to this user manual to understand the complete functionality of WDK and list of options provided for developers before unboxing the WDK development kit to power up and rejoice the developed functionality and options are available for development.

2 Getting Started

2.1 Package Contents

The Wearable Development Kit contains the following:

- Smart Watch with Quick Release Watch Strap
- Docking Station with Snap fit holder and transparent lid.
- Power Adapter(5V/2000mA)
- Type A to Micro Type B USB Cable
- Product Brief Manual
- Warning Sheet



Figure 1: Wearable Development Kit



2.2 Highlighted Features of the Wearable Development Kit



Bluetooth

Bluetooth Low Energy communication is used to communicate with Smart Phone Application and used for Wireless Charging.



Battery Powered

Battery charging is done with the support of Docking Station using Wired Power Supply.



Wireless Charging Enabled

Wearable WDK is the first to demonstrate loosely coupled wireless charging solution. Wireless charging is enabled only in the Smart Watch. To evaluate wireless charging, the user should use an aftermarket AirFuel™ compatible Power Transmit Units (PTU) such as Convenient Power and Gill Electronics.

Caution:The Smart Watch should be evaluated in a single device mode and should not be put on the PTU in the presence of other devices being charged or else there is a risk of damage to this Smart Watch



Display

The higher resolution display is for Smart Watch application and user interface.

2.3 Smart Watch

ON/OFF button

- To **turn ON** the Smart Watch, press and hold the power button for 3 seconds.
- To **turn OFF** the Smart Watch, press and hold the power button for 3 seconds.
 - For more information on powering ON and powering OFF the Smart Watch, read [Power ON/OFF descriptions](#).

LED

- Battery Charging indication is provided by this LED. When the watch is being charged either by Wired or Wireless Charging the LED will be blinking till the battery is completely charged. Once it has been charged the LED glows steadily in Green color.

Display with Touch panel

- User can interact with the Smart Watch through the touch panel.



Figure2: Model of Smart Watch showing Buttons and LEDs

Charging

Charging in Smart watch can be done as Wired or Wireless:

- In Wired Charging the supply can be provided by means of either USB bus power or by an external adapter. When wired supply is connected, an indication is provided on the LCD Display.
- In Wireless Charging the supply can be provided by means of an external PTU. When wireless supply is connected, an indication is provided on the LCD Display.



Figure 3: Wired and Wireless Charging Indication

Note that dead battery wireless charging is not supported by this wearable kit. AirFuel specification is not released to support Cat1 wireless charging. For additional information on how to support dead battery wireless charging, please contact your local ON Semiconductor support team

2.4 Dock Station Model

The Docking Station is mainly used for charging, programming and debugging the Smart Watch.

List of provisions available in the Docking Station

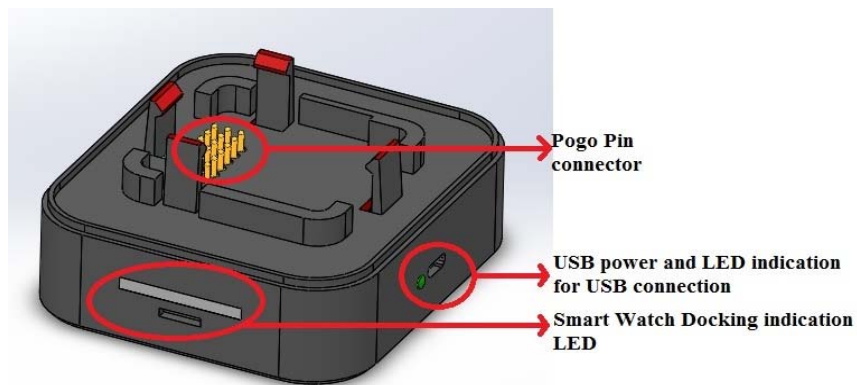

Figure4: Model of Docking Station showing Pogo Pins and USB



- **Pogo Pins**

The spring loaded type test probe like connectors establish the contact between Smart Watch and the Docking Station.

Purpose of Pogo Pins

- 1) Charging the Smart Watch
- 2) Programming and Debugging the Smart Watch
- 3) Additional features in the Smart Watch can be accessed through Docking Station.

Note: Features in Smart Watch are explained separately.

- **B2C Expansion Connector**

The B2C 2x13 Expansion Connector is at the opposite edge of the USB connector.

Purpose of Expansion Connector

- 1) Mainly to utilize the additional features in Smart Watch
- 2) When Smart Watch is not connected to Dock Station, External Expansion Card can be connected to the Docking and its SWD Interface Programming can be utilized.
- 3) At the same time 5V, 3V/1A supply can be provided to power up the Expansion Card using Dock Station.

- **USB Connector and LED**

The Docking Station is powered using the USB Connector through an external adapter 5V/2A or by a USB Down Stream Port. A Blue LED near the USB Connector is provided to indicate when the Docking Station is powered ON

- **Smart Watch Detect Indication**

A Blue LED bar is provided on the side of the Docking Station. The LED blinks when the Docking Station is powered ON and the Smart Watch is not docked. When the Smart Watch is docked, the blinking of LEDs comes to a halt and the Blue LED glows continuously.

- **Docking Indication**

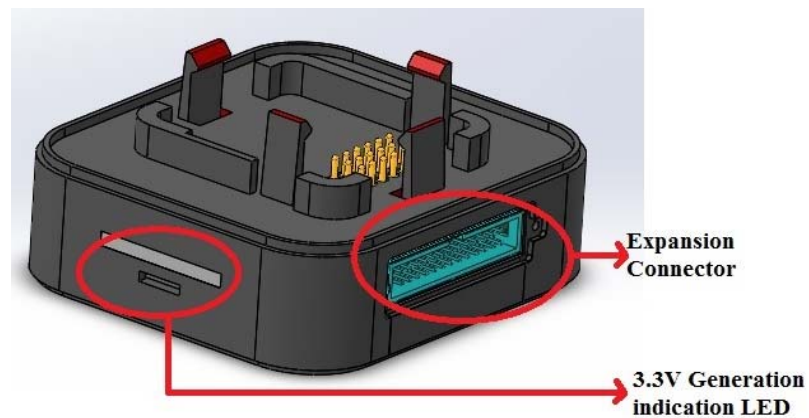

Figure 5: Model of Docking Station showing the Expansion Connector

- **3.3V Indication LED**

A Green LED is present opposite of the Dock Indication LED. This is used to indicate the generation of 3.3V in the dock.

- **Expansion Card Detection Indication**

Once the Expansion Card is connected via Expansion Connector a Red LED glows and green LED will be turned OFF.

- **Snap Fit Holder**

This is used to hold the Smart Watch to the Docking Station. First, the Smart Watch is placed followed by the Snap Fit Holder.

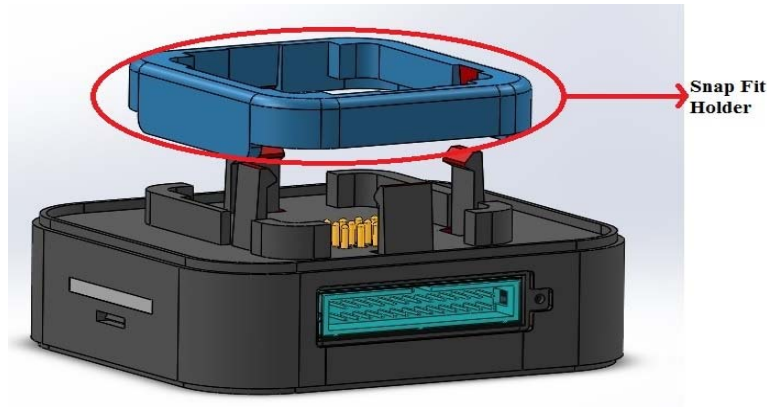



Figure 6: Model of Docking Station showing the Snap Fit Holder

2.5 Application Download

- For Android devices, install the ON Semiconductor WDK Mobile Application from the  Play Store.
 - For Information about the ON Semiconductor WDK Android Mobile Application functionality, features and supported mobile phones read [Android Mobile Application](#).
- For iOS devices, install ON Semiconductor WDK Mobile Application from the  App Store.
 - For Information about ON Semiconductor WDK iOS Mobile Application functionality, features and supported mobile phones read [iOS Mobile Application](#).

3 Charging

The Smart Watch is connected to the Docking Station for Wired Charging. The Docking Station is powered either by an External adapter or through USB bus supply. .

3.1 Wired Charging

- Plug the USB cable into a power outlet and insert the micro USB Connector in the Dock Station. The Blue LED to the side of the Docking Station will blink until the Smart Watch is docked Smart Watch.
- Once the Smart Watch has been docked, the Blue LED will start glowing continuously
- Figure 7- shows the connection of Smart Watch to the Docking Station.
 - The Smart Watch is docked to the Docking Station such that the Pogo pins in the Docking Station are connected with the Pogo Connector in Smart Watch.
 - The Snap Fit Holder is then placed on top of the Smart Watch such that it attaches to the Snap Fit Pillars

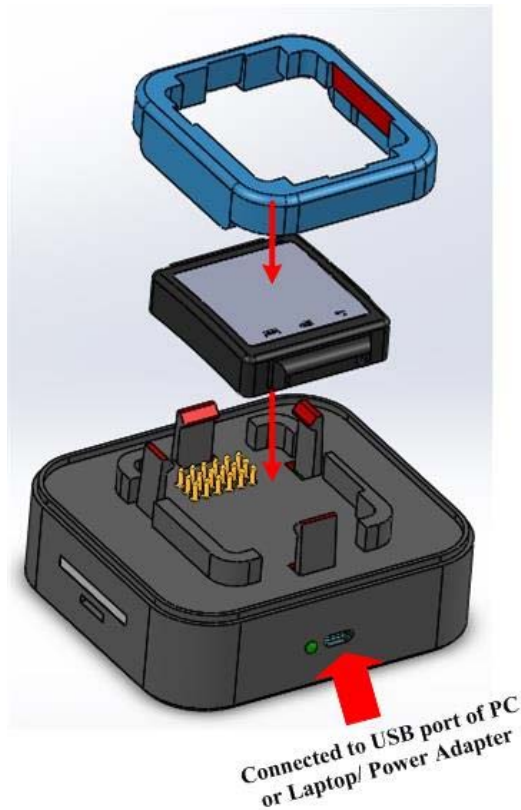

Figure 7: Steps for Charging Smart Watch

- Battery level can be seen through battery bars or in the Mobile Application (If Connected).
- The Green Charging Indication LED on top right corner of the WDK will blink every second when charging.
- When the Battery is Fully Charged, the Green LED on the Watch will glow steadily.
- User can remove the watch from the Dock Station when the Green LED glows steadily.

4 Programming/Debugging

Programming/Debugging can be done for the following devices. The Microcontroller to be programmed will be selected based on the below priority

1. Smart Watch nRF52832
2. Expansion Card ARM processor
3. Docking Station nRF52832

4.1 Smart Watch

- Once the Smart Watch is docked properly on the charging dock. User can program or Debug the code in the Smart Watch.
- Refer IDE User guide for Programming /Debugging procedure.
- The Smart Watch can be removed from the Dock Programming/Debugging.

4.2 Expansion Card

The Expansion Card is mainly used to probe the signals from Smart Watch. It is also used to provide a provision for User to interact with the GPIO of the Smart Watch. The below figure shows the overall Block Diagram including the Smart Watch, Docking Station, and Expansion Card.

The Docking Station can also Program the Expansion Card through its SWD signals.

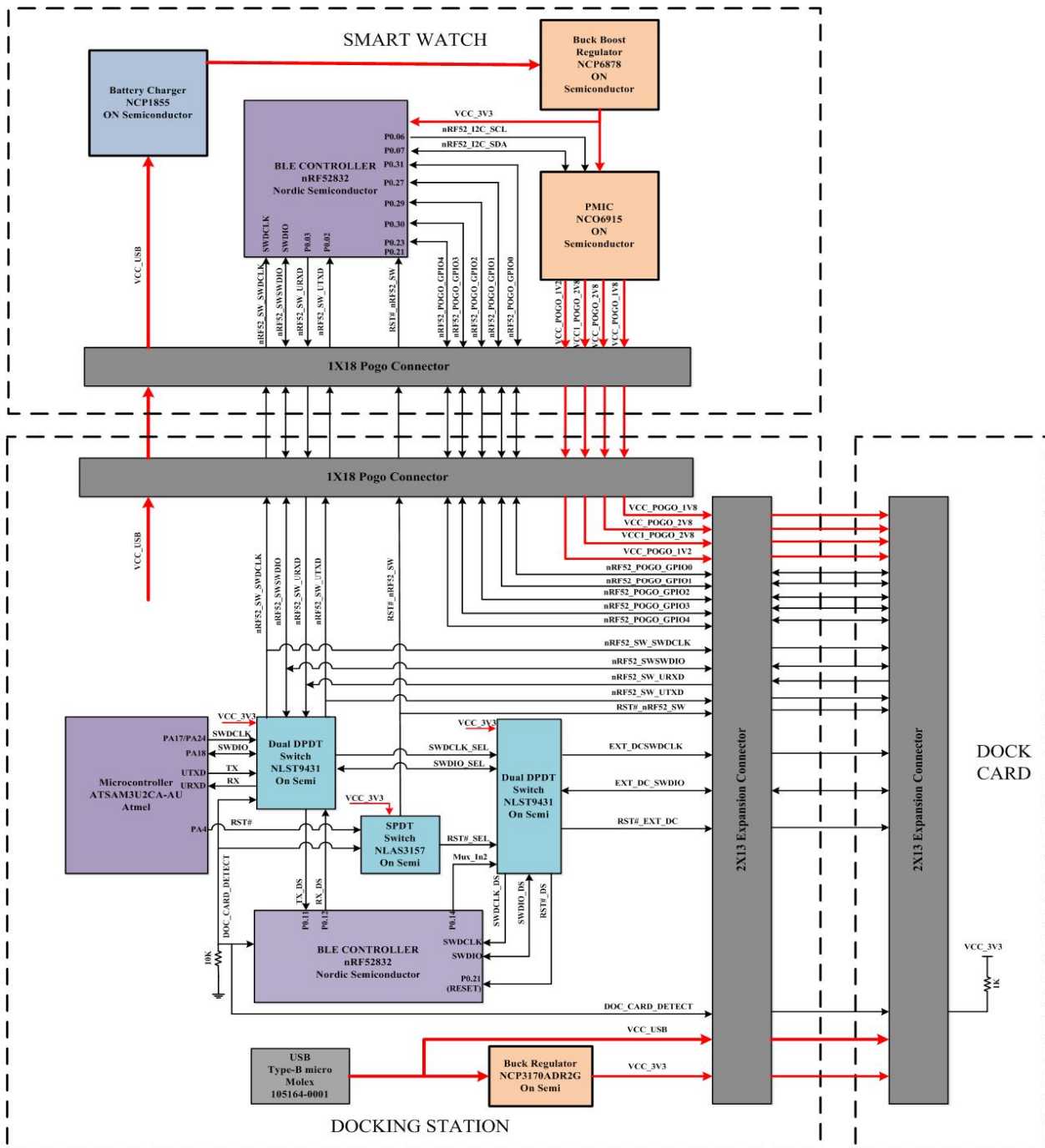

Figure 8: Expansion Card Block Diagram

Note:

Programming of External Expansion Card SWD interface is alone supported. Debugging feature is not provided.

4.2.1 Expansion Connector

- An Expansion Connector provides a provision for accessing the various reserved signals from the Smart Watch.
- The below image shows the image of the Expansion Connector and its first pin marking. The below table shows the various pins in the connector and its corresponding functionalities

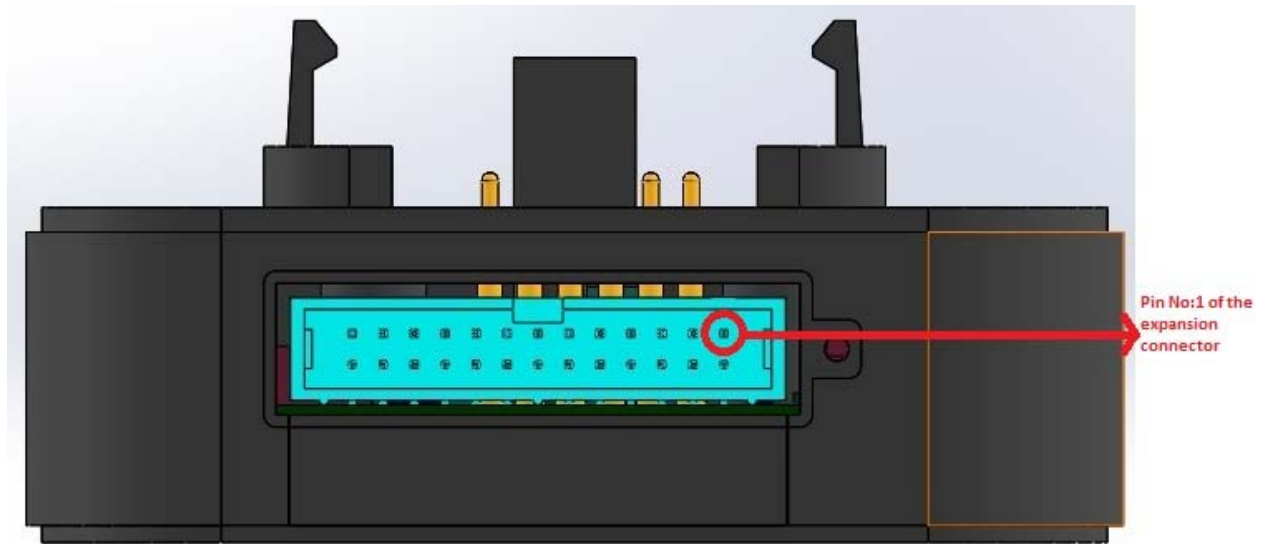

Figure 9: Expansion Connector Pin 1 Indication

Pin No	Connection Net	Functionality
1	VCC_USB	5V power supply from USB. Used to power up the Expansion Card devices.
2	VCC_POGO_1V2	1.2V power supply from Smart Watch. Used to connect to an external device
3	VCC_USB	5V power supply from USB. Used to power up the Expansion Card devices
4	VCC_3V3	3.3V power supply generated in Docking Station from 5V.
5	VCC_POGO_2V8	2.8V power supply from Smart Watch. Used to connect to an external device
6	VCC_3V3	3.3V power supply generated in Docking board from 5V.
7	VCC1_POGO_2V8	2.8V power supply from Smart Watch. Used to connect to an external device
8	nRF52_SW_SWCLK	To probe the JTAG clock signals used for coding the Smart Watch from Docking Station
9	EXT_DC_SWCLK	JTAG clock signals used for coding an external device by the Docking Station
10	nRF52_SW_SWDIO	To probe the JTAG data lines used for coding the Smart



Wearable Development Kit User Manual

Watch from Docking Station		
11	EXT_DC_SWDIO	SWD data lines used for coding an external device by the Docking Station
12	RST#_nRF52_SW	To probe the SWD Reset signals used for resetting the Smart Watch from Docking Station
13	RST#_EXT_DC	SWD reset signal to reset an external device from the Docking Station
14	VCC_POGO_1V8	1.8V power supply from Smart Watch. Used to power an external device
15	GND	Ground
16	GND	Ground
17	GND	Ground
18	GND	Ground
19	nRF52_SW_URXD	Used for probing the UART Receiver signals from Docking Station to Smart Watch
20	nRF52_POGO_GPIO1	GPIO reserved for User interaction with the Smart Watch
21	nRF52_SW_UTXD	Used for probing the UART Transmitter signals from Docking Station to Smart Watch
22	nRF52_POGO_GPIO2	GPIO reserved for User interaction with the Smart Watch
23	nRF52_POGO_GPIO0	GPIO reserved for User interaction with the Smart Watch
24	nRF52_POGO_GPIO3	GPIO reserved for User interaction with the Smart Watch
25	DOC_CARD_DETECT	Used to detect when an external Expansion Card is connected to the docking board. User must add an external pull up of 1K to 3.3V to this line
26	nRF52_POGO_GPIO4	GPIO reserved for User interaction with the Smart Watch

The below table provides the maximum current that can be consumed from each rail.

Maximum Current consumed (mA)					
VCC_USB	VCC_3V3	VCC_POGO_2V8	VCC1_POGO_2V8	VCC_POGO_1V8	VCC_POGO_1V2
Based on input source	1000	200	200	200	600

- When powered from USB downstream post, Maximum Input power is 2.5W. In this Smart Watch consumes maximum of around 1.5W. Balance power to be consumed from all other rails must be around 1W to Expansion Card.
- When powered from an External Adapter, Maximum Input power is 10W. In this Smart Watch consumes maximum of 1.5W. Balance power to be consumed from all other rails must be 8.5W

Power rails of 2.8V, 1.8V and 1.2V are solely obtained from the Smart Watch. It is generated from a PMIC (NCP6915). Each of these rails can be programmed through the I2C interface present in the nRF52832 present in Smart Watch.

The below table shows the Register 08 which needs to be configured to enable each power rails.

Name: ENABLE				Address: \$08			
Type: RW				Default: \$80			
D7	D6	D5	D4	D3	D2	D1	D0
DCDC_V2/V1	spare = 0	DCDC_EN	LDO5_EN	LDO4_EN	LDO3_EN	LDO2_EN	LDO1_EN

4.2.2 Expansion Card Details

The following points to be followed by User when connecting an Expansion Card to the Docking Station and to program it

Automatic Expansion Card Detect

- The Expansion Card must have a 1K pull up to the connector Pin No 25 externally for the Docking Station to sense the connection of Expansion Card
- The Smart Watch must be removed from the Docking Station in order to program the Expansion Card.

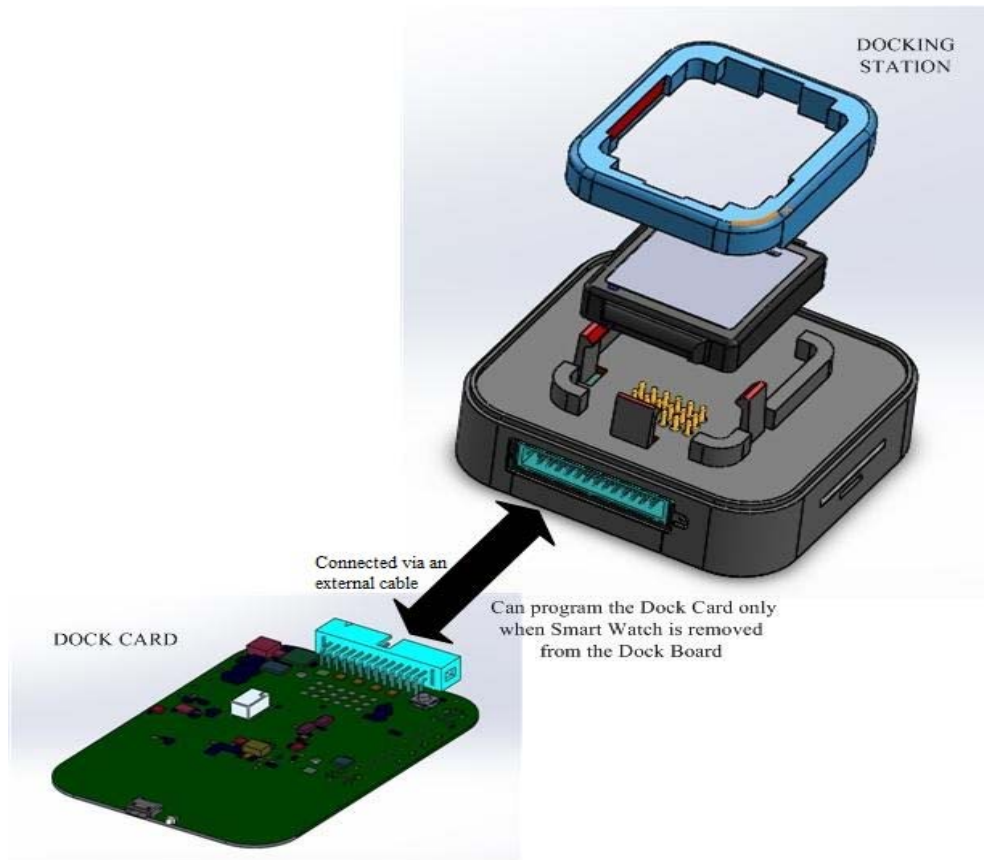

Figure 10: Programming of Dock Card

- The Docking Station by default provides 5V and 3.3V. During this period only Docking Station or Expansion Card can be programmed.

- The priority of programming using SWD signals comes in the following order:
 1. Smart Watch
 2. Dock Card
 3. Docking Station
- If the Smart Watch is connected to the Docking Station only, the signals from the Smart Watch can be probed.

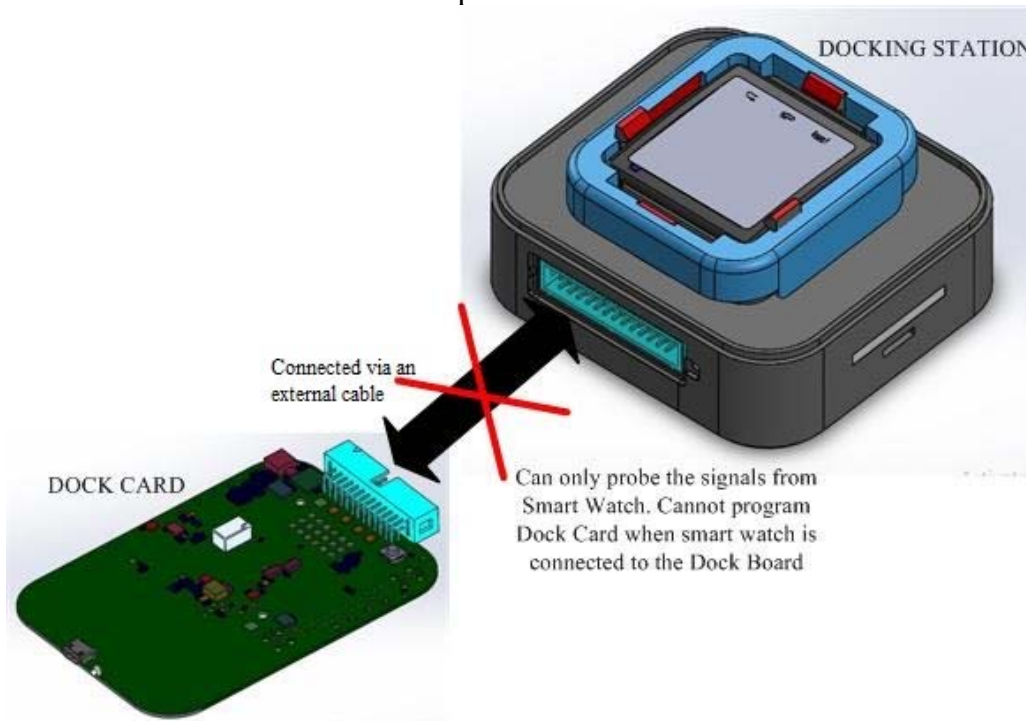

Figure 11: Probing of Smart Watch Signals

- The external SWD signals can be used to only program the Expansion Card. It cannot be used to debug the Expansion Card as the UART signals are not tapped out from the Expansion Card.
- The mating connector to be used to tap out signals from the expansion connector is the 30320-5002HB part from 3M INTERCONNECT SOLUTION is used. This Header part mates with the 3M Wire mount Socket, 79 Series, CHG series, 891 series, and 3000series.

4.3 Docking Station nRf52_BLE Chip









- Once the Watch & dock card are removed from the Charging dock, User can program or Debug the code in the Docking Station.
 - Refer IDE User guide to Program Dock Station nRF52832.





5 Features and Settings

This includes ON Semiconductor WDK Features.

5.1 List of Icons

	Menu Icon
	BLE Settings icon
	Settings icon
	BLE icon
	Close Icon
	Timer Icon
	Stopwatch icon
	Alerts Enabled
	Alerts Disabled

5.2 Screen Buttons

- Menu Button : Pressing  will show the list of utilities.
- Home Button : Press  to return to the Home Screen.
- Back Button : Press  to return to the previous screen or exit the current utility.



5.3 System Control

5.3.1 Power ON/OFF

This includes how to Power ON and Power OFF the Smart Watch.

Power ON

- Press and hold the Power button for 3seconds to Power ON the Smart Watch.
- When the Smart Watch is Powered ON, the Display will activate and the **ON Semiconductor** logo will be displayed on the Screen for a short duration after which an Analog or Digital clock will be displayed based on the previous settings.



Figure 12: ON Semiconductor logo

Power OFF

- Press and hold the Power button for 3 seconds to Power OFF the Smart Watch.
- When Smart Watch is Powered OFF, a “Goodbye” message will be displayed on the Screen and Display will be turned OFF.

5.3.2 Battery Status

- Battery Status can be seen in Status Bar located at the top of the Home Screen and also in the Smart Phone Application when connected.

5.3.3 Low Battery/Critical Low Battery

Low Battery:

- When Battery level reaches **40%**, a “**Low Battery Alert**” Notification will be displayed in Smart Watch and an alert notification will be sent to the Smart Phone, if in a connected state.
- When Battery level reaches **20%**,a“**Low Battery**” Notification will be displayed in Smart Watch and Smart Watch will enter into “**Low Power Mode**”.



- In Low Power Mode,
 - Display will be turned OFF.
 - Touch Interrupt will be disabled.
 - All the peripherals will be disabled.
- Long Pressing the Power Button for 3seconds will show the Charging Status of the Smart Watch.
- If Smart watch is charging, by Long Pressing the Power Button, a **“Charging”** Notification will be displayed in the Smart Watch.
- If Smart Watch is not charging, by Long Pressing the Power Button, a **“Low Battery, Connect Charger”** Notification will be displayed in the Smart Watch.

Critical Low Battery:

- When battery level reaches **10%**, **“Critical Low Battery”** Notification will be displayed in Smart Watch and the Smart Watch will enter into **“Critical Low Power Mode”**.
- In Critical Low Power Mode,
 - Display will be turned OFF.
 - Touch interrupt will be disabled.
 - All the peripherals will be disabled.
 - Power Button is also disabled

NOTE:

- If Smart Watch is charging, and when the battery level reaches **25%**, Smart Watch will automatically enter into Active Mode.

5.3.4 Screen Lock

- When the Smart Watch is in an ON state, the screen will be locked automatically if there is no user input for 20seconds.
- A Short Press of Power Button can be used to lock and unlock the screen manually.

5.3.5 Auto-Sleep

- In Standby Mode, if there is no activity in the watch for one minute, then the Smart Watch will enter Sleep Mode.
- In Sleep Mode, all the peripherals will be disabled and the Smart Watch will consume less power.

5.3.6 Wake On Motion

- Wake On Motion is turned ON in standby mode and sleep mode.
- If any motion is detected in Standby Mode, the Smart Watch will remain in Standby Mode, and it will not enter Sleep Mode.
- If any motion is detected in Sleep Mode, the Smart Watch will exit from Sleep Mode and it will enter to Active Mode.

5.4 BLE Control

5.4.1 Turn ON BLE

- By default BLE is turned ON.
- BLE can be turned ON manually in the BLE Settings Screen.
- Click the BLE Settings icon on the Home Screen, and the BLE Settings screen will be displayed.
- Tap on the Status Button on the BLE Settings Screen from OFF to ON to turn on the BLE.
- Go back to the Home Page by pressing the Back Button in the BLE Settings Screen.
- Check Status Bar (Top bar) in Home Screen. If BLE is turned ON, BLE icon will be displayed. When the BLE is turned ON the Home Page will look like as shown in the below image.



Figure 13: Home page with BLE ON

5.4.2 BLE Advertisement

- By default, the Smart Watch will advertise with name of format “ON_xx:yy:zz” Where xx/yy/zz are last 3 bytes of the MAC address.
- The Smart Watch BLE Name can be configured from Smart Phone Application.

5.4.3 Turn OFF BLE

- BLE can be turned OFF in the BLE Settings Screen.
- Click the BLE Settings icon on the Home Screen, then BLE Settings Screen will be displayed.
- Tap on the Status Button on the BLE Settings Screen from ON to OFF to turn OFF the BLE.
- Go back to the Home Page by pressing the Back button in the BLE Settings Screen.
- Check the Status Bar at the top of the Home Screen. If BLE is turned OFF, the BLE icon will not be displayed.



5.4.4 Connect/Disconnect with Smart Phone

5.4.4.1 Mobile Scanning

- Turn ON Bluetooth on the Mobile Device and the BLE on the Smart Watch. By Default Bluetooth is turned ON in Smart Watch.
- Search list of nearby devices from Mobile and Connect to required Smart Watch.
- Once connection has been established, a bond is created between Smart Watch and Smart Phone.
- Once a bond is created with Smart Phone, this Smart Watch cannot connect to any other Smart Phone.
 - For Information about pairing to an Android Device read [Set-up and pair with Android Mobile App](#).
 - For Information about pairing to an iOS Device read [Set-up and pair with iOS Mobile App](#).

5.4.4.2 Auto-Connect

- If the Smart Watch goes out of the Smart Phone's Range, it will disconnect. The Smart Watch will Auto-Connect once it enters back the range of Smart Phone.
- Auto-Connect do not happen, if the user manually disconnects the Smart Watch..

5.4.4.3 Disconnect from Smart Phone

5.4.4.3.1 With Bond Deletion

- Tap Delete Bond from Mobile Application.
- Tap Disconnect from Mobile Application.
- Now the Smart Phone will disconnect from the Smart Watch and any Bond information will be Deleted from Mobile Application
 - For more information on Deleting Bonds from the Smart Watch read [BLE Forget Device](#).
 - For more information on Deleting Bond from an Android Device read [Delete Bond from Android Mobile App](#).
 - For more information on Deleting Bond from iOS Device read [Delete Bond from iOS Mobile App](#).

Caution:

If user wants to Delete Bond, User should Delete Bond on both Smart Watch and Smart Phone, otherwise the Smart Watch and Smart Phone behavior will be undefined.

5.4.4.3.2 Without Bond Deletion

- Tap Disconnect in Settings from Mobile Application.
- Now the Smart Phone will disconnect from the Smart Watch.



5.4.4.4 BLE Forget Device

- **“Forget Device”** button will be enabled and BLE Name of the Smart Phone is displayed in Smart Watch BLE Settings Screen.
- To connect to any other device, Click on **the “Forget Device”** button in BLE Settings Screen. Then Forget [BLE Name of Smart Phone] Button will be disabled in Smart Watch BLE Settings Screen.

5.5 In-built Utilities

5.5.1 Clock Selection

Clock Screen will be displayed when Back Button is pressed from Home Screen. The clock to be displayed (analog/digital) can be chosen from the Settings option.

5.5.1.1 Analog Clock

- Select the Analog Clock by tapping on the Analog Clock Icon on the Home Screen followed by Settings Icon.
- Then select the Analog Clock Button. After selecting Analog Clock User can see the clock by pressing Back Button on Home Screen.

5.5.1.2 Digital Clock

- Select the Digital Clock by tapping on the Digital Clock Menu Icon on the Home Screen followed by Settings Icon.
- Then select the Digital Clock Button. After selecting Digital Clock User can see the clock by pressing Back Button on Home Screen.

5.5.2 Time Settings

Time can be auto-synchronized with Smart Phone (if connected) or User can manually set the time.

5.5.2.1 Turn ON Auto-Synchronization

- To turn ON Auto-Synchronization tap Menu Icon on the Home Screen followed by Settings Icon.
- Tap on Clock Settings Button and select Auto-Sync
- A notification will be displayed on the Smart Watch once synchronization is completed.
- User can see the synchronized time on the Home Screen by tapping Home Button.

5.5.2.2 Manual Settings

- To enable Manual Settings, tap the Menu Icon on the Home Screen followed by Settings Icon.
- Tap on Clock Settings Button and disable Auto-Sync
- Tap on Manual Settings, now User can set the time manually.
- The user can see the newly set time on the Home Screen by pressing Home Button.



5.5.3 Timer

- To set Timer, tap Menu Icon on the Home Screen followed by **Timer** Icon.
- After setting the Timer, User can start it by clicking the Okay Button on the Timer Settings Screen.
- User can Cancel / Start / Stop the Timer.
- The Timer can run in background by pressing the Home Button in Timer Settings Screen.
- Once the set time is reached, a pop will be shown on the Smart Watch display with Vibration.
- Smart Watch will not enter Standby Mode, if it is in the Timer Screen.

5.5.4 Stopwatch

- To start the Stopwatch, tap the Menu Icon on the Home Screen followed by “**Stopwatch**” Icon.
- User can pause or reset the Stopwatch.
- The Stopwatch can run in background by pressing the Home Button in Stopwatch Settings Screen.
- The Smart Watch will not enter Standby mode, if it is in Stopwatch Screen.

5.5.5 Alerts

- By enabling Alerts User can see the Notifications on the Smart Watch.
 - To enable Alerts, tap the Menu Icon on the Home Screen and tap on “**Alerts Icon**”
- By disabling Alerts User will not see any Notifications on the Smart Watch.
 - To disable Alerts, tap Menu Icon on the Home Screen and tap on “**Alerts Icon**”.



Figure 14: Menu Screen with Notification Alerts Enabled

5.6 Configurations from Smart Phone Application

For all the below configurations done from the Smart Phone Application, the Smart Watch and Smart Phone should be in a connected state.



5.6.1 BLE Name Update

- In the Smart Phone Application, set required BLE Name for the Smart Watch.
- BLE Name will update on the BLE Settings Screen on the Smart Watch.
- The Smart Watch will there after advertise with this newly configured BLE Name
 - For information about updating the BLE Name on an Android Device read [Update BLE Name from Android Mobile App](#).
 - For information about updating the BLE Name on an iOS Device read [Update BLE Name from iOS Mobile App](#).

5.6.2 Haptic Feedback

- In the Smart Phone Application, enable Haptic Feedback in Settings
- Vibration can be felt for all Notifications received on the Smart Watch.
 - For information about controlling Haptic Feedback Settings on an Android Device read [Haptic Feedback in Android Mobile App](#).
 - For information about controlling Haptic Feedback Settings on an iOS Device read [Haptic Feedback in iOS Mobile App](#).

5.6.3 Motion Sensor Data

- Auto-Sync should be enabled while turning ON the Motion Sensor.
 - For information about turning ON the Auto-Sync on the Smart Watch read [Turning ON Auto-sync in Smart Watch](#).
- In Smart Phone Application, enable Motion Sensor Data in Settings.
 - For information about Enabling/Disabling Motion Sensor Data Settings on an Android Device read [Enabling/Disabling Motion Sensor Data from Android Mobile App](#).
 - For information about Enabling/Disabling Motion Sensor Data Settings on an iOS Device read [Enabling/Disabling Motion Sensor Data from iOS Mobile App](#).

5.6.4 Brightness Settings

- Tap on the Brightness Setting Seek Bar in the Setting Screen.
- Brightness in the Smart Watch will vary accordingly.
 - For information about changing brightness from an Android Device read [Changing Brightness from Android Mobile](#).
 - For information about changing brightness from an iOS Device read [Changing Brightness from iOS Mobile](#).

5.6.5 Clock Settings

Analog or Digital Clock can be selected from Smart Phone Application

- For information about setting clock from an Android Device read [setting Clock from android mobile app](#).



- For information about setting digital clock from an iOS Device read [setting Clock from iOS mobile app](#).

5.7 Display Notifications

5.7.1 Connect to a Smart Phone

- Scan from Smart Phone and Connect to Smart Watch.
- After connection, **“Connected to [Smart Phone BLE name]”** will be displayed on the Smart Watch Screen.

5.7.2 Disconnect from Smart Phone

- After disconnection, **“Disconnected from [Smart Phone BLE name]”** will be displayed on the Smart Watch.

5.7.3 Fitness Goal Notification

- Enable Fitness Goal Notifications on the Smart Phone by connecting to the Smart Watch
- Select the option to set the goal for Steps / Calories to be Burned / Active Time /Distance Travelled on the Smart Phone
- Set Your Goal
- Enable Motion Sensor in Smart Phone connected to Smart Watch
- When Fitness Goal is achieved, the following strings will be displayed on screen based on the Fitness Goal set,
 - Steps Goal - “Steps goal for the day has been achieved”
 - Calorie Goal - “Calorie goal for the day has been achieved”
 - Active time Goal - “Active time goal for the day has been achieved”
 - Distance Goal - “Distance goal for the day has been achieved”
- Go back to the previous screen by either tapping the Close Button displayed on top right corner of the Notification Screen or by pressing the Back Button.
 - For information about setting Fitness Goals from an Android Device read [Setting goals from android mobile app](#).
 - For information about setting goals from an iOS Device read [Setting goals from iOS mobile app](#).

5.7.4 Call Notification

- Make a call to the Smart Phone connected to the Smart Watch.
- **“[Caller Name] Calling”** will be displayed on the Screen.
- Go back to the previous screen by either tapping the Close Button displayed on top right corner of the Notification Screen or by pressing the Back Button.



5.7.5 SMS Notification

- Send an SMS to the Smart Phone connected to the Smart Watch.
- “Message from [**Sender Name**]” will be displayed on the Screen.
- Go back to the previous screen by either tapping the Close Button displayed on top right corner of the Notification Screen or by pressing the Back Button.

5.7.6 Alarm Notification

- Set the Alarm from the Smart Phone.
- When the Alarm Time is reached “**Alarming...**” will be displayed on the Screen.
- Go back to previous screen by either tapping the Close Button displayed on top right corner of the Notification Screen or by pressing the Back Button.

5.7.7 Download Notification

- Download a file to the Smart Phone when connected to the Smart Watch.
- A Download Completion pop-up will be displayed on the Smart Watch Screen.
- Go back to previous screen by either tapping the Close Button displayed on top right corner of the Notification Screen or by pressing the Back Button.

6 Android Mobile Application

6.1 Supported Devices

The following Operating Systems are supported:

- Android: **Versions Supported (Android version 4.4 and above)**
 - Lollipop (5.0).
 - Marshmallow(6.0)
 - KitKat (4.4)+
- While installing the application, a popup will be shown to enable the notification permission. If the notification permission is not enabled for the application, Alarm Notification and Download Notification cannot be shown. But Call, SMS, Fitness Notification can be shown.

6.2 Application Overview

- The Application uses a Bluetooth low energy (BLE) technique.
- If Bluetooth is turned off, the application will prompt to enable the Bluetooth through a popup.



Wearable Development Kit User Manual

- Once the Smart Watch and Application get connected, Bonding will be created between the Smart Watch and the Smart Phone. No other phone can connect with the Smart Watch until Bond is deleted.
- Once the Bonding is deleted from any of these two (Smart Watch and Smart Phone), Bonding in the other should be deleted. Otherwise connection will not be proper.
- There is option for deleting Bond in the application as well as in Smart Watch.
- If the connection is lost from the Smart Watch side, then the application will try to auto connect with the Smart Watch.

6.3 List of Features

Below is the sequence of screens which will be loaded while using this application.

6.3.1 Installation

While installing the ON Semiconductor WDK Android Application, the steps to be followed are -

- Install “ON Semiconductor WDK” app from the  Play Store.
- It will lead to the installation screen as shown below. Press the install option.

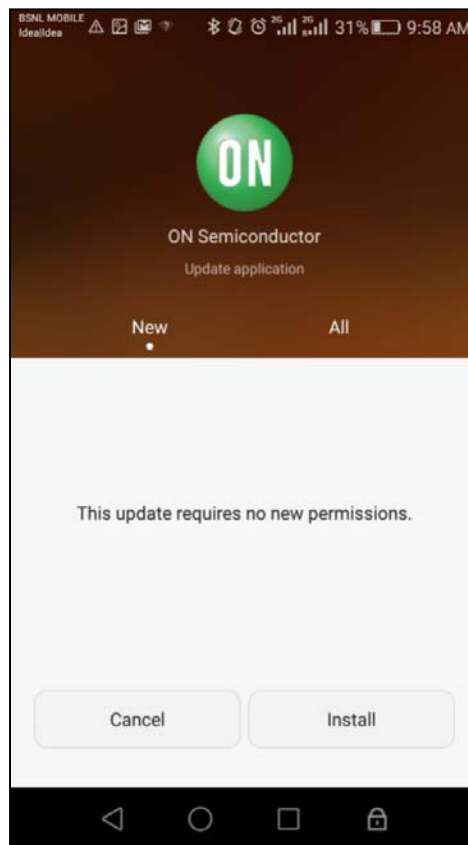

Figure15: Installation process



- Installing process is as shown below

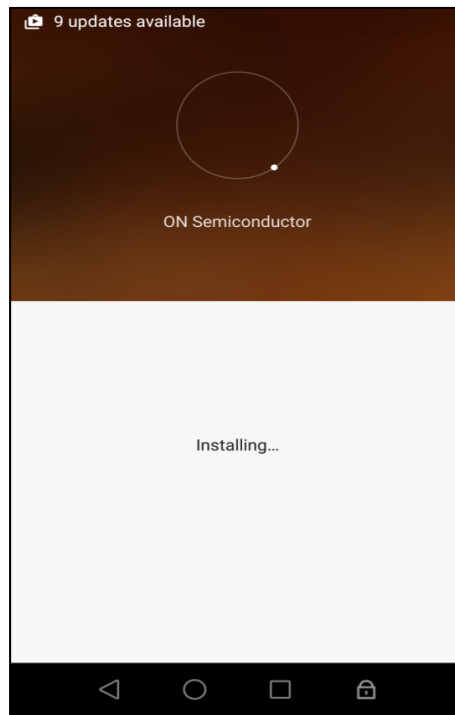

Figure16: Installing option

- The below figure shows the installed screen

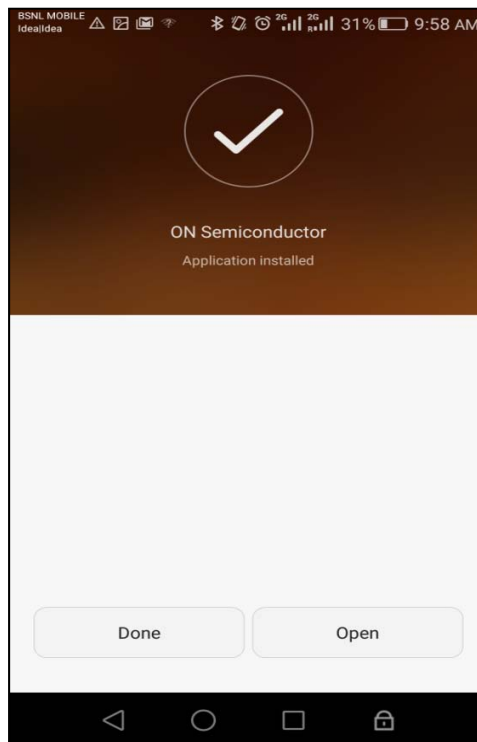

Figure17: Installed apk screen



- Once the installation is done, choose the Open from the screen. The Application will start with a Splash Screen.

6.3.2 Splash Screen

Splash Screen with Logo as shown below will be displayed for 3 seconds.

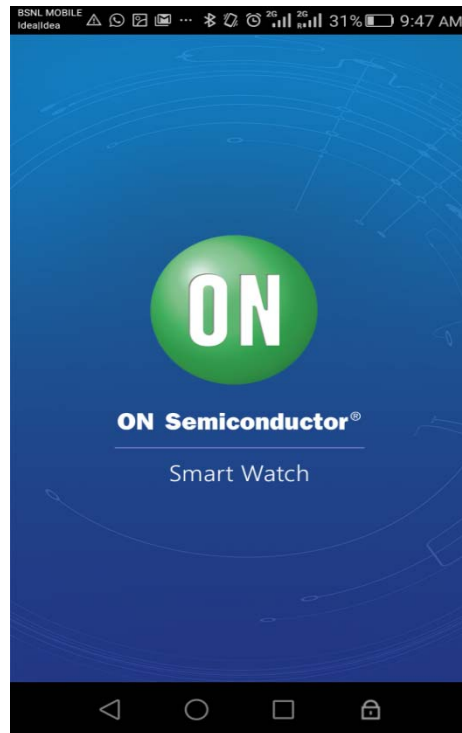

Figure18: Splash screen

6.3.3 Enabling the Permission for Notification

After the Splash Screen, the following sequence of screens will be displayed prompting User to enable the Notification Permission on the phone (**Version Lollipop and Marshmallow**) as shown in the **Fig.17**.

Note:

- In **KitKat** N Permission will be given while installing the Application. Hence Application will not prompt User for the same when launched.
- If the Notification Permission is not enabled, the Smart Watch will not get the Alarm Notification and Download Notification. Call, SMS and Fitness Notification will be notified.

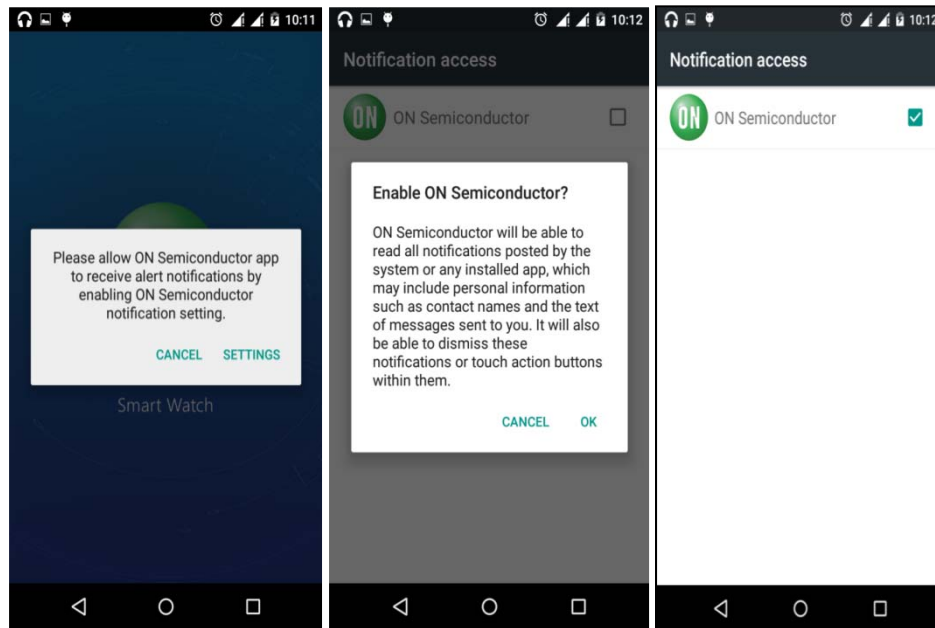

Figure19: Enable the notification permission

- Choose the Settings option from the pop up, it will lead to the next screen to enable the notification for the ON Semiconductor Application.
- Choose OK option from the popup.
- Then the screen will be shown as above.
- Then press the Back Button.
- It will lead to the initial Smart Watch Connection Screen as shown **Fig.18**

6.3.4 Initial Watch Connect Screen

- In this screen, User can scan for new watch by tapping on Icon.
- Taping the Watch Icon will lead to the Guidelines Screen as shown below

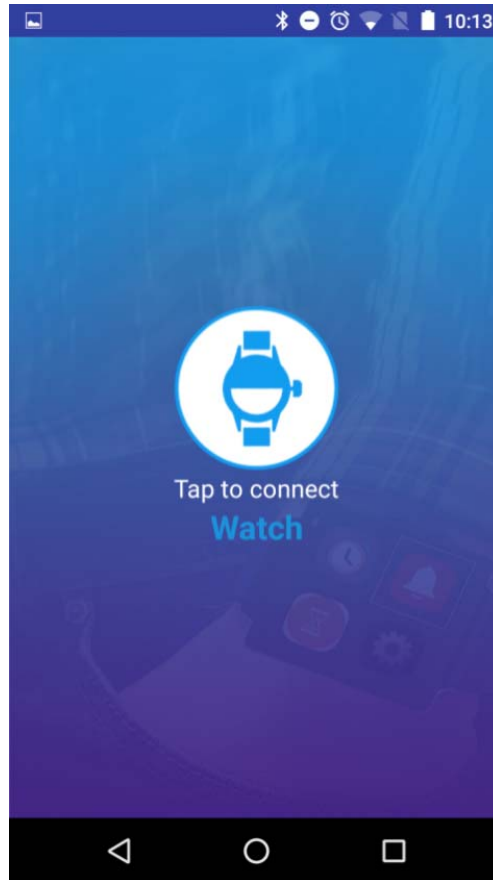

Figure20: Initial Watch Connection Screen



6.3.5 Guidelines Screen

The Guidelines Screen will appear after tapping on the Watch Icon on the Home Screen. This screen will contain various guidelines to user that will help in pairing the Smart Watch with the Smart Phone. Tap on the Scan Button from the screen.

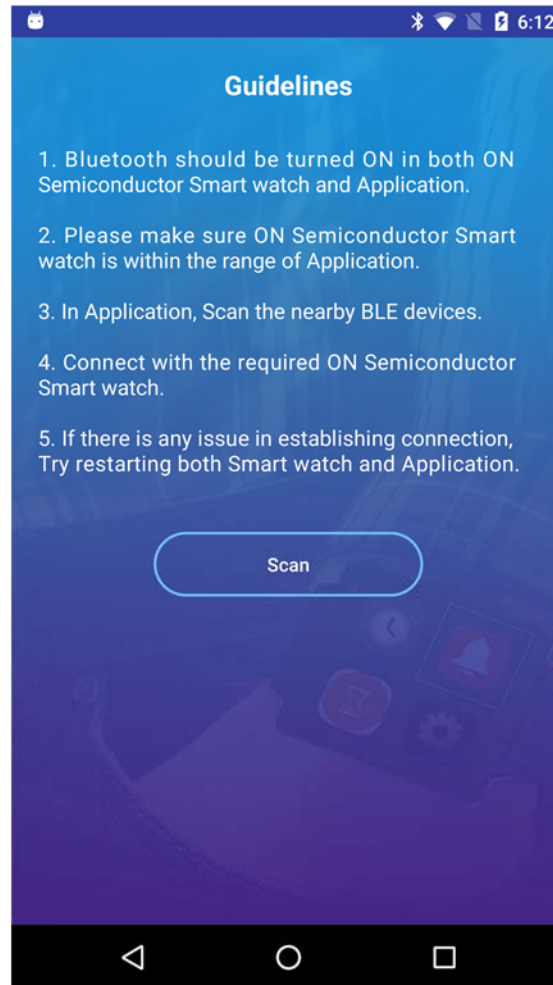

Figure21: Guidelines Screen

6.3.6 Turning ON the Bluetooth Device

After tapping the Scan Button on Guidelines Screen, if Bluetooth is not already turned ON, then there will be a popup asking to turn on Bluetooth,

- Tap “**Turn ON**” option from the popup.
- Then it will start scanning for the nearby available devices.

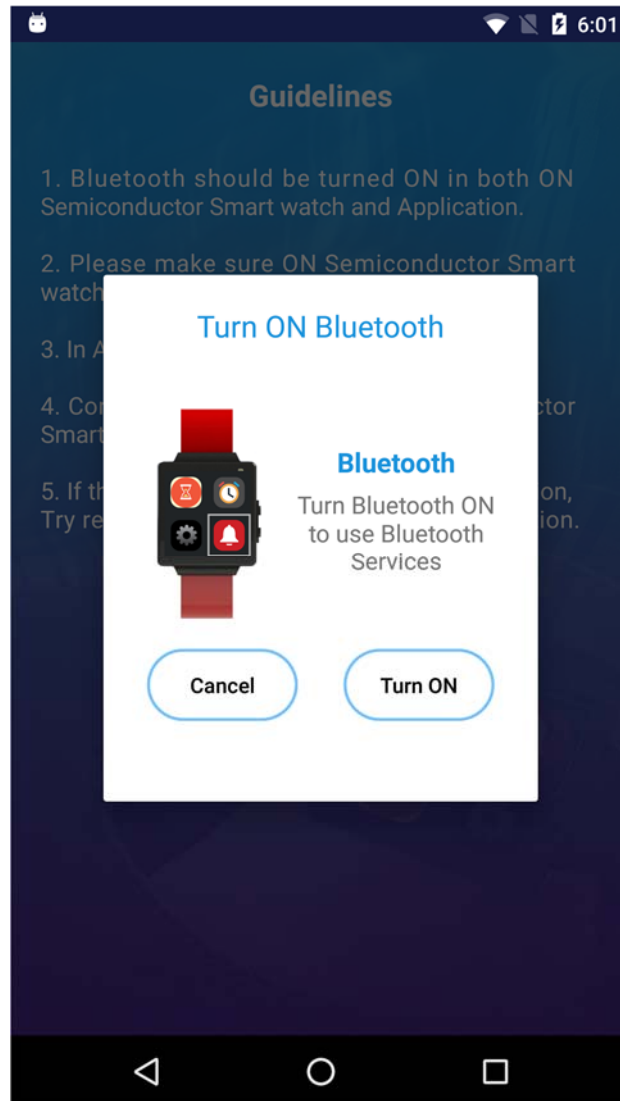

Figure22: Bluetooth ON Permission Popup

6.3.7 List of Nearby BLE Devices

This screen will show the list of all nearby available BLE Devices. The screen also contains Refresh Icon. By tapping on Refresh Icon, it will refresh the list with the BLE Devices nearby.

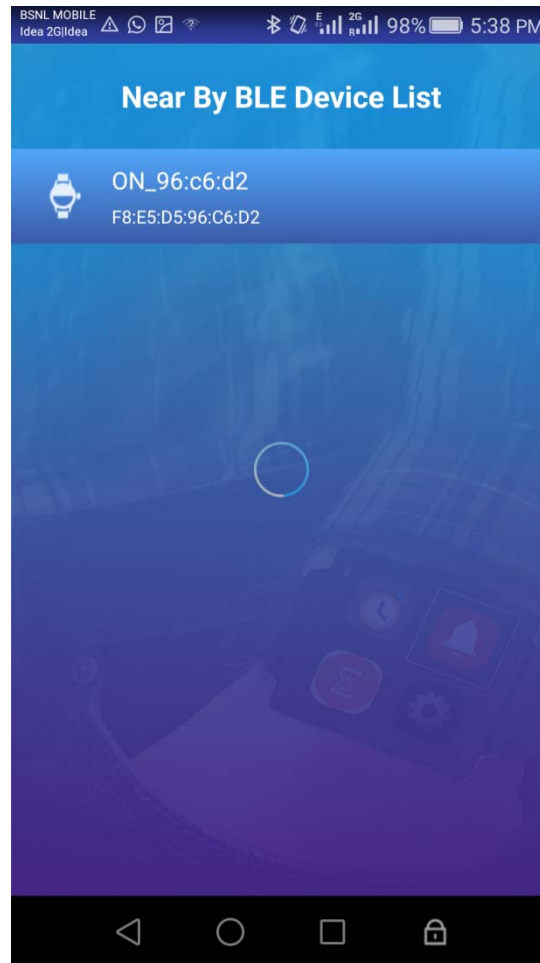

Figure23: Available Devices Name

- When tapping on the Device Name to connect with, a popup will appear as shown in the **Fig.22**.
- There will be three options Cancel, Connect and Delete Bond. By tapping the Connect option, User can establish connection with the Smart Watch.

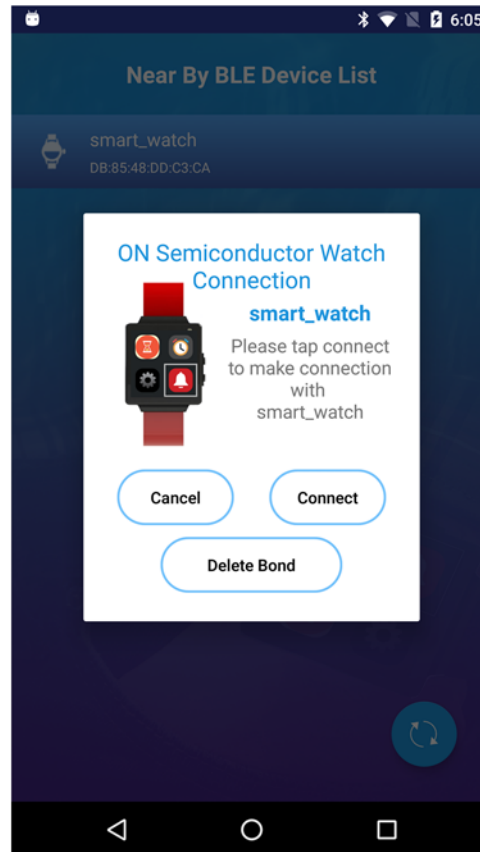

Figure24: Connect with the selected device

Note:

1. If the Delete Bond Option is in enabled state means (as shown in the **Fig. 23**), the Smart Phone is Bonded with the Smart Watch.

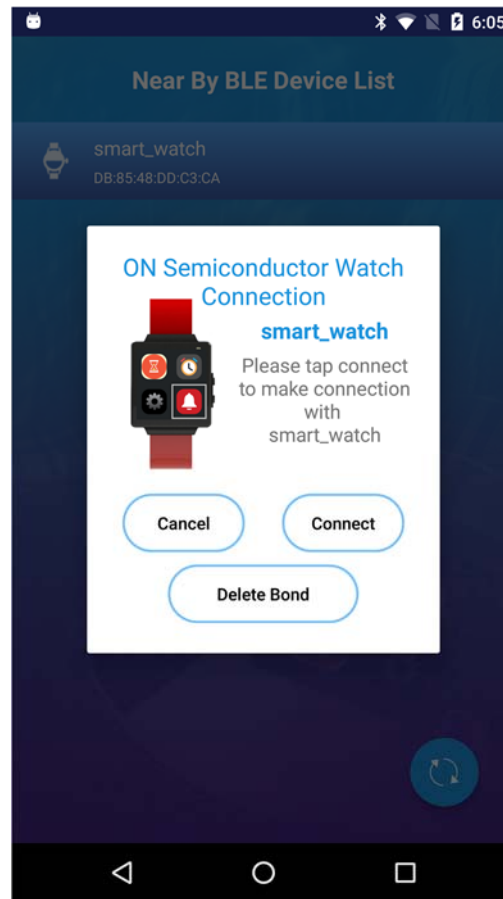

Figure25: Connect with the Smart Phone (Delete Bond is in Enabled State)

2. If the Smart Watch also has Bonded with that Smart Phone, then tap on the Connect Option. The communication will be working properly.
3. If the Smart Watch is not bonding with the Smart Phone trying to connect with, and the Application is showing the Delete Bond option in an enabled state, then tap on the delete bond option to delete the bond. User can tap again on the watch name and connect with it.
4. After successful connection between Smart Watch and Smart Phone, User will be directed to the Home Screen (History Screen).

6.3.8 History Screen

After the establishment of Connection, the History Screen will be shown as shown in **Fig.24**. In the History Screen, there are three views on the header - Day, Week, and Month. By tapping on each view, respective details will be shown in the screen. There is a Progress Bar in the center; showing the progress of the action. On sliding on the view inside the Progress Bar - Steps walked, Distance travelled, Calories burned and Active Time will be shown. The name of connected Smart Watch and its battery percentage will also be shown in the screen. If the Smart Watch is in disconnected state, its name and the battery percentage will be shown in grey color, everything else in white color. And Fitness History is shown in the bottom of the screen by using the recycler view.

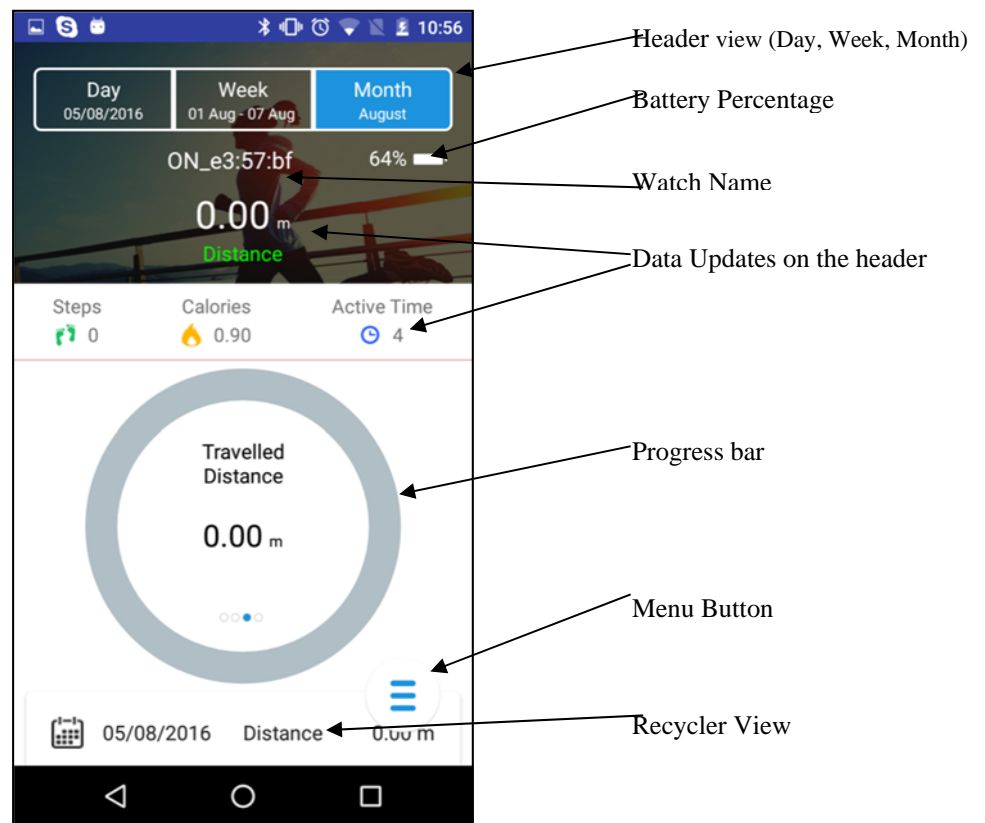

Figure26: Home Screen



6.3.8.1 Menu Screen

On tapping the floating Action Button, the Menu option will be shown.

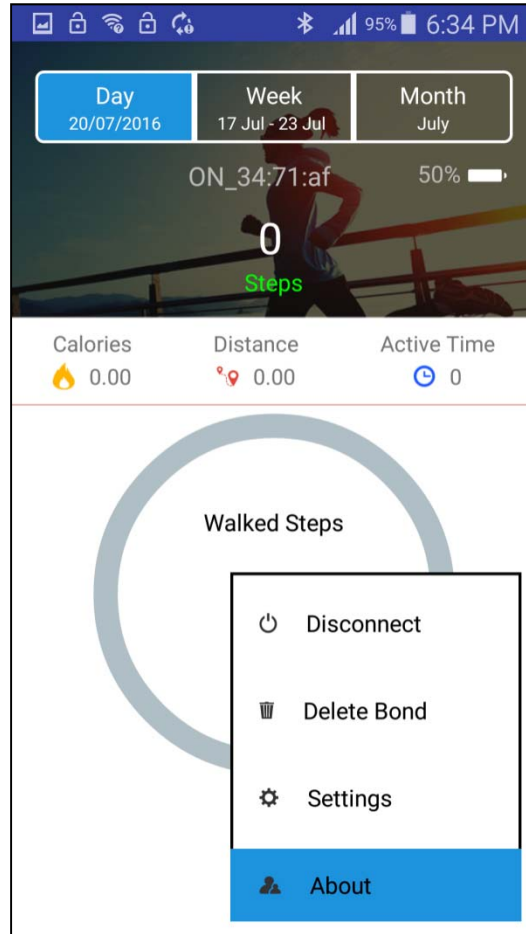

Figure27: Menu Screen



Below options are available in Menu Screen.

1. **Settings:** When tapping the Setting Button, the user will be redirected to the Settings Screen to change the settings of the Application.

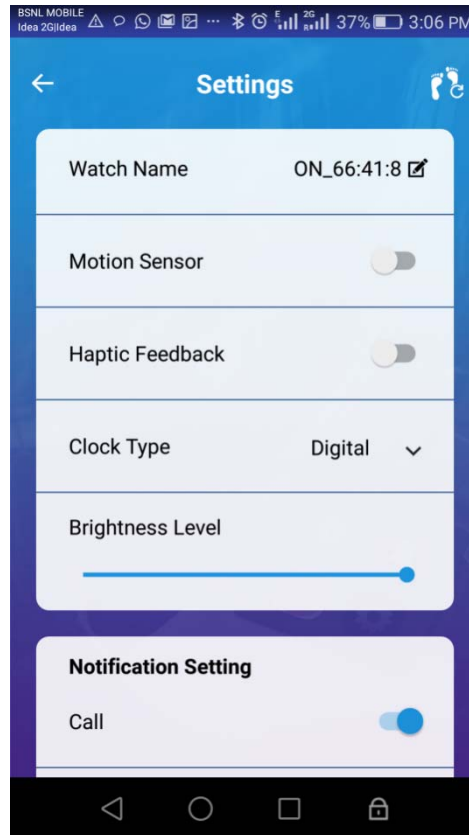

Figure28: Settings Screen



2. **About Us:** By tapping About Us from the Menu Option, the user will be redirected to an About Us Screen. The current version of the mobile application and watch firmware version is shown on the About Us Screen.

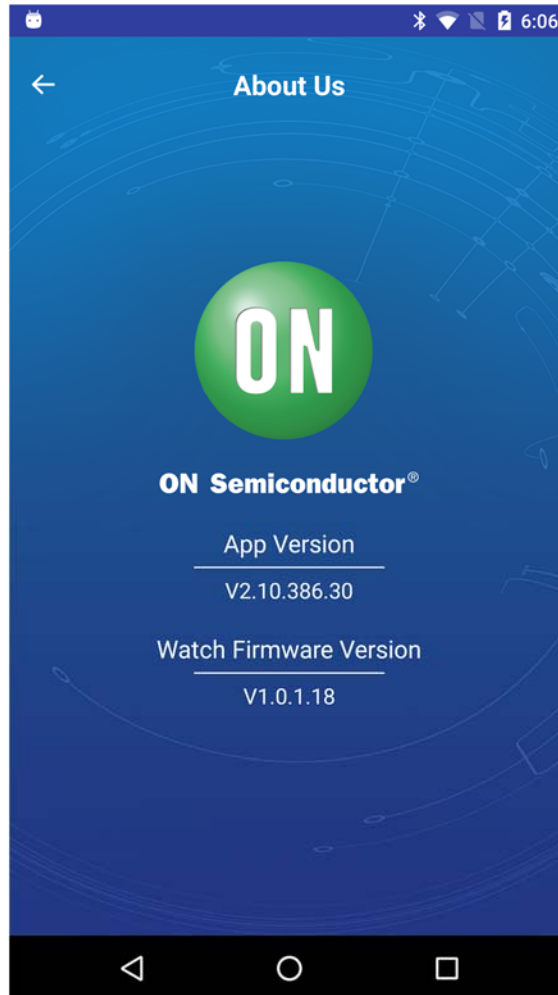

Figure29: About UsScreen



3. **Disconnect:** The user can manually disconnect the application with the Smart Watch by clicking the Disconnect option from the Menu.

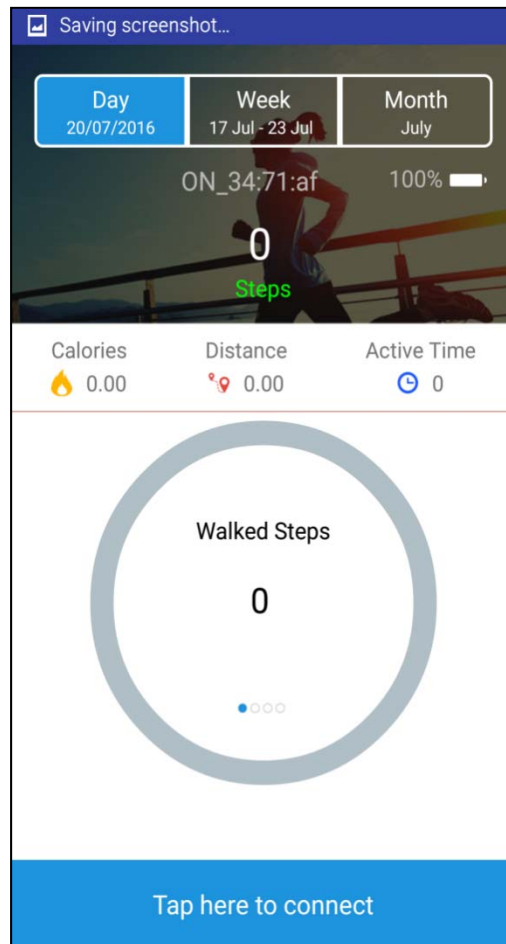

Figure30: Disconnected Screen



4. **Delete Bond:** Using the Delete Bond option from the Menu Button, the user can delete the bond between the Smart Watch and Application. The sequences of screen are as shown in the **Fig.29.Once the bond is deleted from the ON Semiconductor WDK Application; the bond on the Smart Watch also should be deleted.**

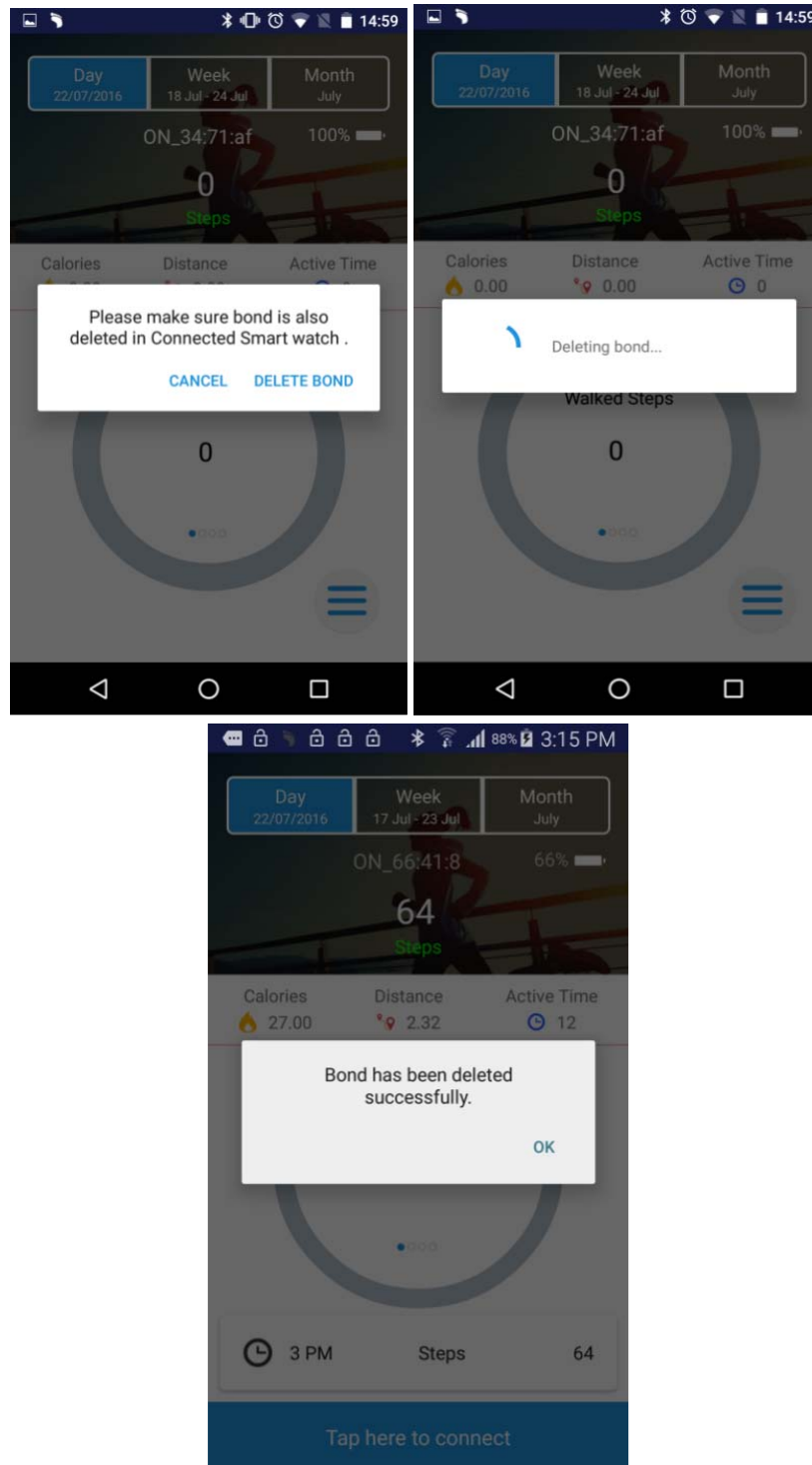

Figure31: Delete bonding

Note:

If the mobile application is bonding with the Smart Watch, a popup will be shown to check the bonding state in the application. Upon tapping the Yes option, the Bond will get deleted from the application side as shown in the Fig.30.

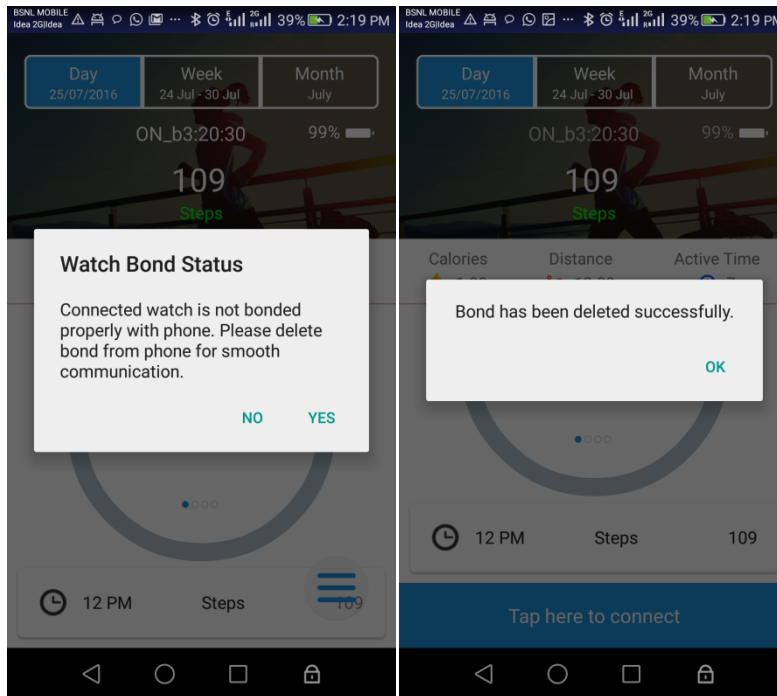

Figure32: Checking the Bond State and Disconnecting

6.4 Configuration Settings

From the Settings Screen various features can be controlled.

6.4.1 Smart Watch name

User can edit the Smart Watch name from the mobile application, when the Smart Watch and Application are in connection. A popup will be shown upon tapping the Edit Watch Name text as shown in the **Fig.31**. The new name can be given there. Smart Watch will display with the new name. The name size is limited by 13 characters.

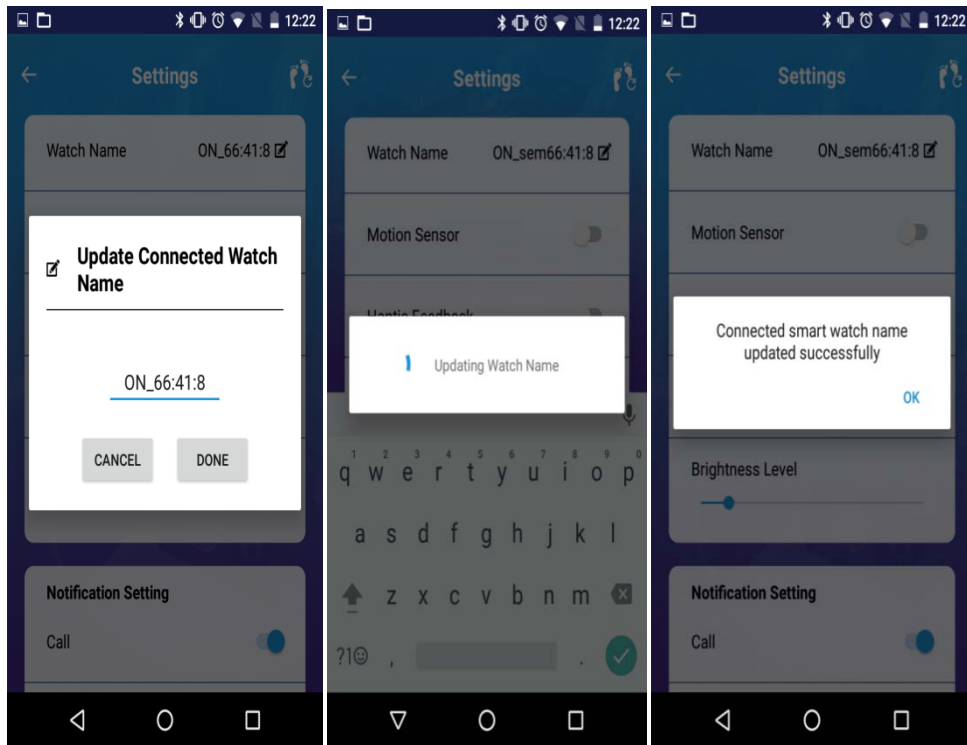

Figure33: Edit the Watch Name

6.4.2 Motion Sensor

Once the Motion Sensor is turned ON in the application, the Smart Watch will start sending the Step Count to Smart Phone every fifth second. While enabling or disabling the Motion Sensor, a popup will be shown. Sequences of popup screens are as shown in the **Fig.32**.

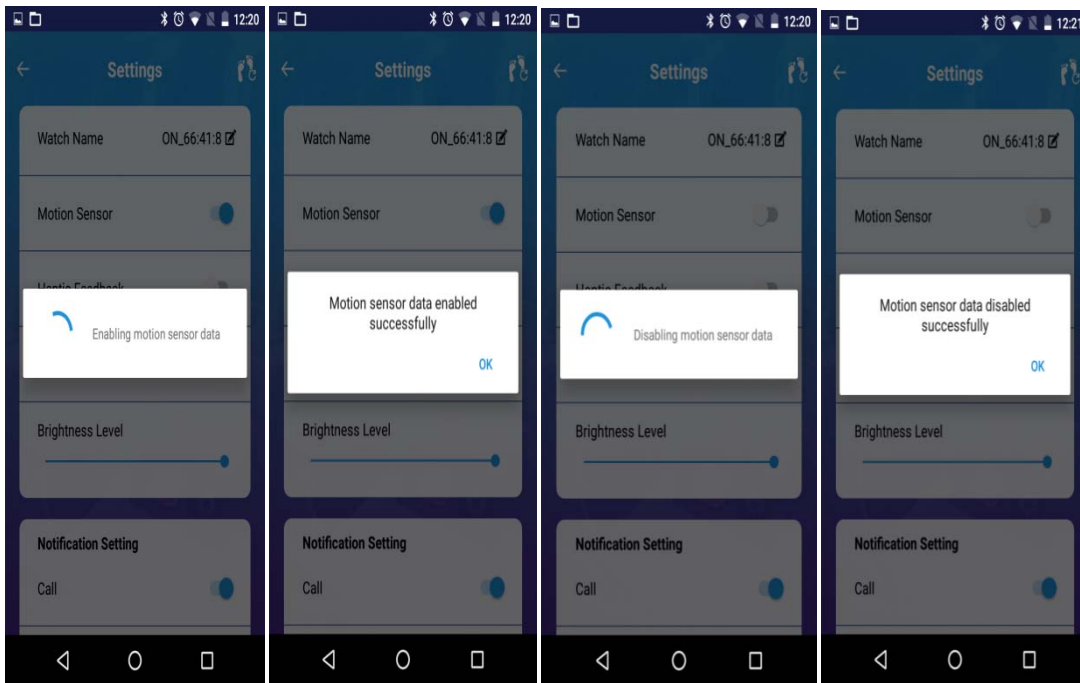

Figure34: Motion Sensor-Enable-Disable

Note: Resetting the Data

- There is an option for resetting the data in the database. There is a Reset Button on the top right corner in the Settings Screen as shown in **Fig .33**.

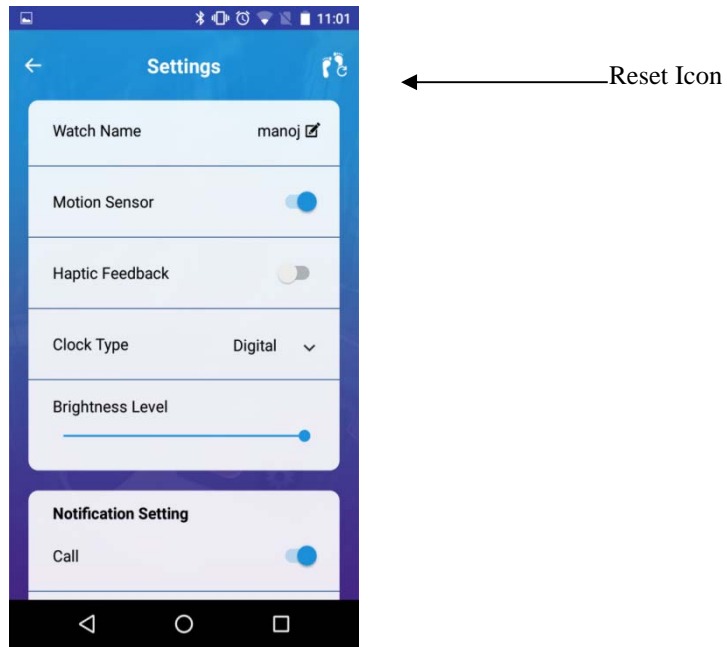

Figure35: Reset Button

- On tapping on the Reset Button, the previous data stored in the database will be reset. The screens are as shown in the **Fig.34**.

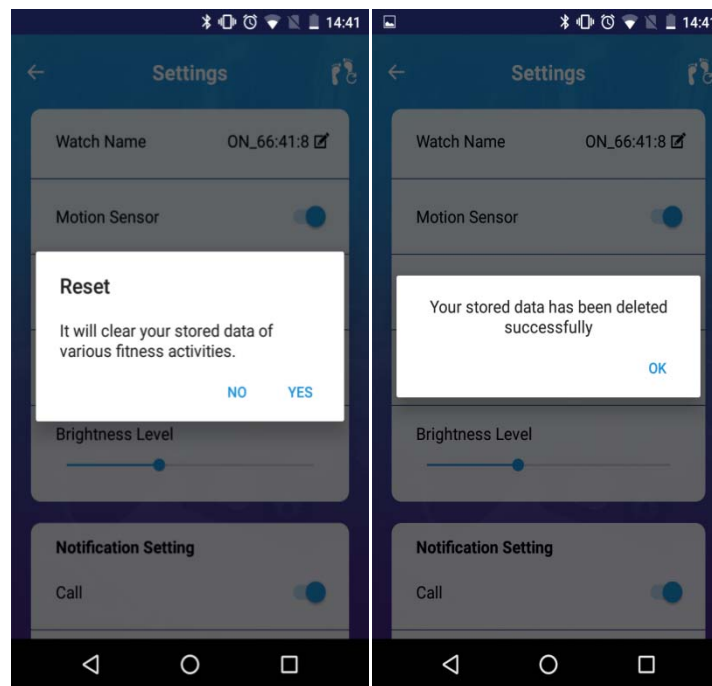

Figure36: Resetting the Data



6.4.3 Haptic Feedback

Haptic Feedback can be turned ON from the Application. Once the Haptic Feedback is turned ON, the Smart Watch will receive Haptic Feedback (vibration) for all Notifications received from phone. A popup will be shown while enabling the Haptic Feedback and after getting the acknowledgment from the Smart Watch as follows. When the Haptic Feedback is disabled, then also popup will be shown showing the disabling as well as the acknowledgment as shown in the **Fig.35**

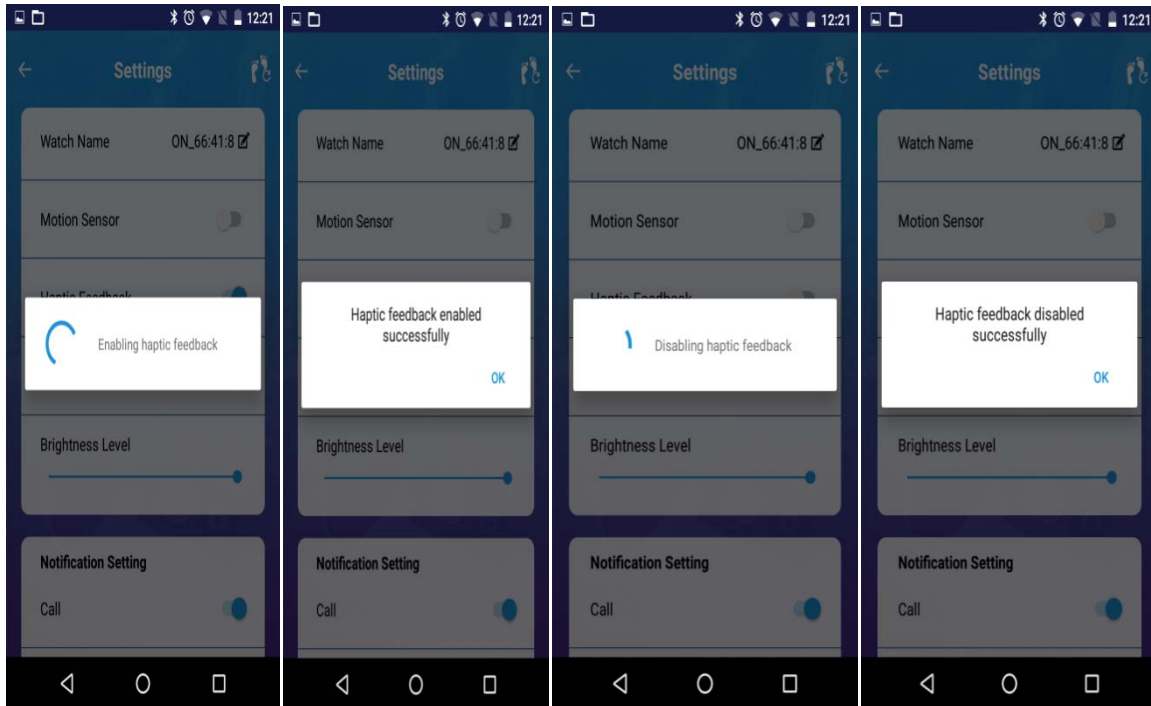

Figure37: Haptic Feedback-Enable-Disable

6.4.4 Clock Type

User can choose the clock type from the drop down box.

1. Digital
2. Analog

Once User chooses the Analog from the drop down, the Smart Watch will set the clock type as Analog and vice versa as shown in the **Fig.36**.

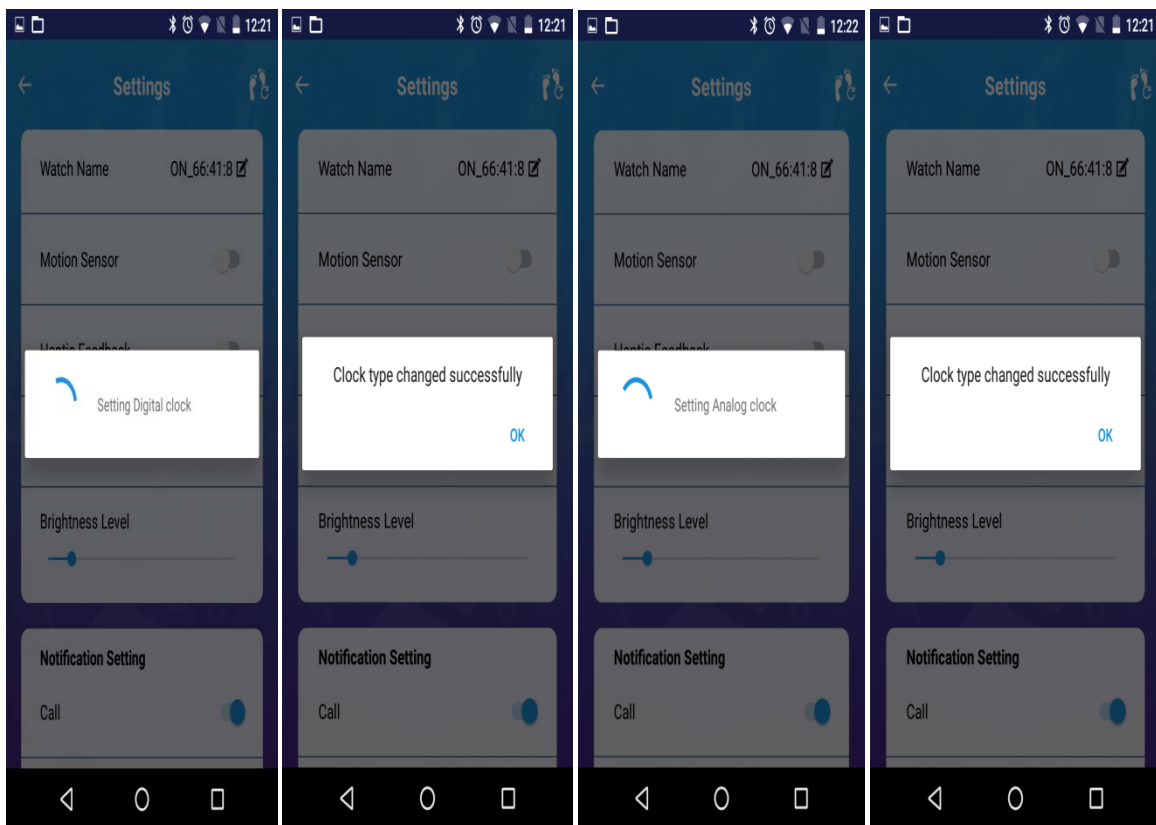

Figure38: Clock Type

6.4.5 Brightness Level

User can adjust the Brightness Level of the Smart Watch screen from the ON Semiconductor Application using the Seek Bar in the Settings screen. If the brightness updating is successful, a popup will be showing as shown in the **Fig. 37**.

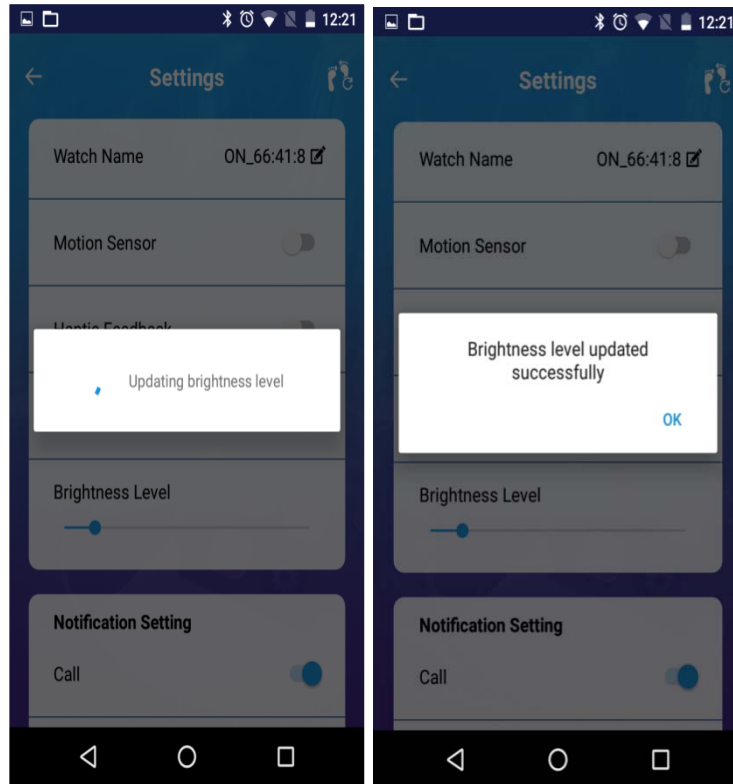

Figure39: Brightness Control

6.4.6 Notification Settings

From the Settings we can enable or disable the Notifications to the Smart Watch.

1. Call Notification
2. SMS Notification
3. Alarm Notification
4. Fitness Notification.

- When Notifications are enabled, all the above events will be notified to Smart Watch.
- The user has the option to set the Fitness Goal for the day in the Settings Screen. Once the Goal is achieved, Notifications will be sent to the Smart Watch.

The Setting Screen for enabling Notification and Fitness set up is as shown in the **Fig. 38**.

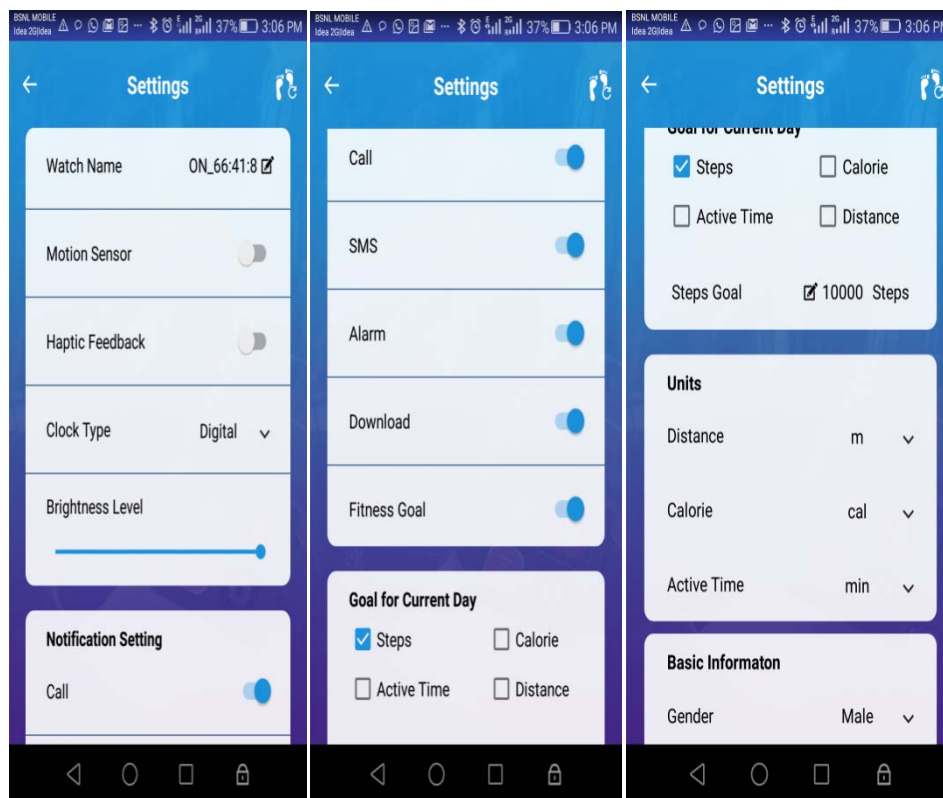

Figure40: Notification and Fitness Settings Screen

- User can set the Fitness Goal for the day. If no values are set, application will set a default value as the goal. Once the goal is reached, a notification will be sent to the Smart Watch. Additionally, there are options to fill User basic information like height, weight, age which is necessary to calculate the parameters.

6.4.7 Goal Settings

User can set a goal to be achieved for the day. There is option to set the goal for Steps, Calories to be Burned, Active Time (working out time), and Distance to be covered. Upon clicking on each option, a popup will be shown. Users can set the goal value. The popup screens are shown in the **Fig. 39**.

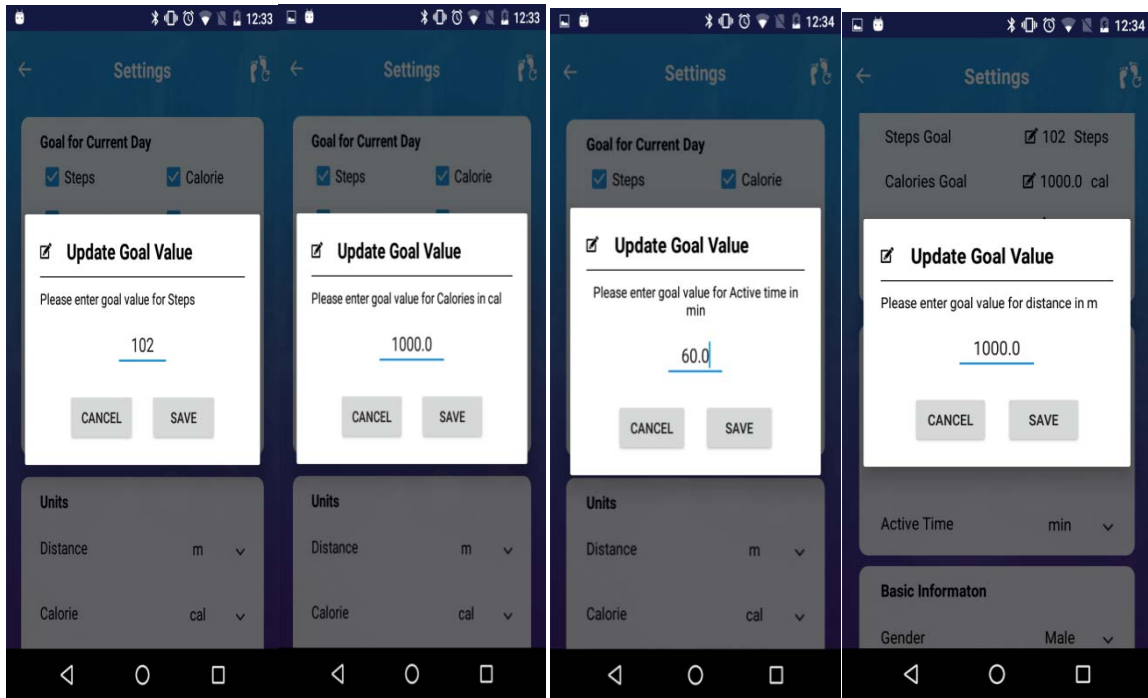

Figure41: Setting the Goal Value for Steps, Calories, Active Time and Distance

The Goal Notification Screens are as shown in **Fig. 40**.

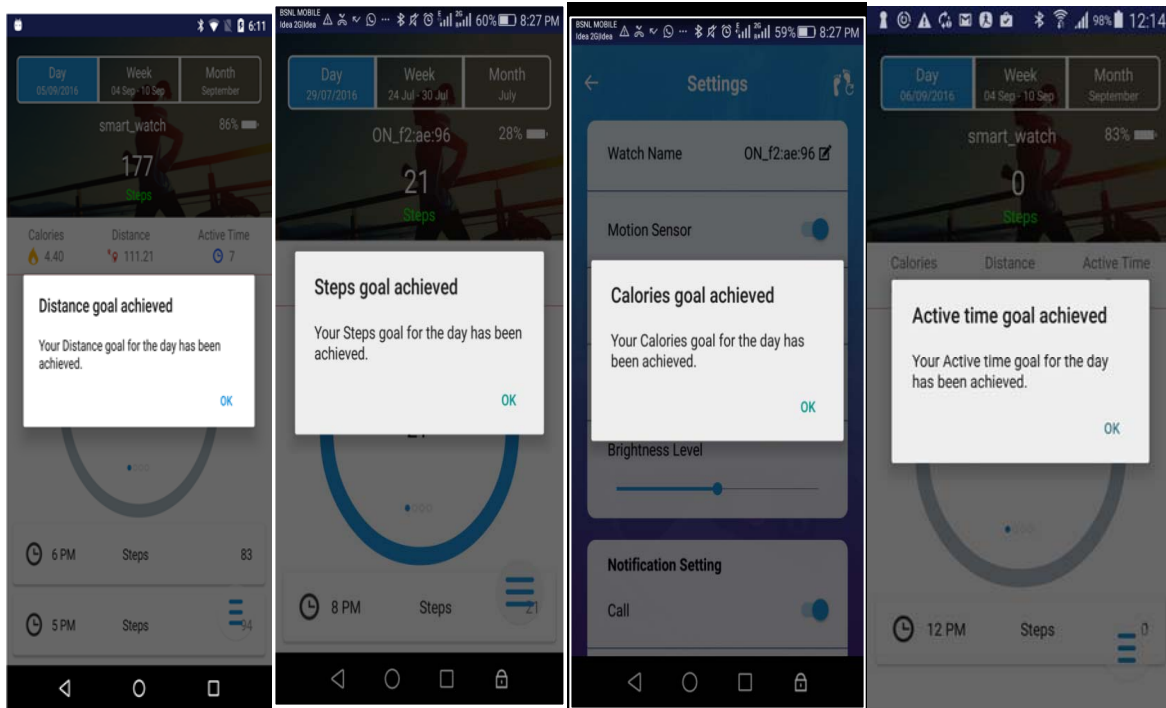

Figure42: Goal Notification

6.4.8 General Information about the User

User can provide the information about Gender, Height, Weight, and Age. Upon clicking each option, a popup will appear. User can enter the details and save. The details will be saved in the local database. The screens are shown as follows in the **Fig.41**.

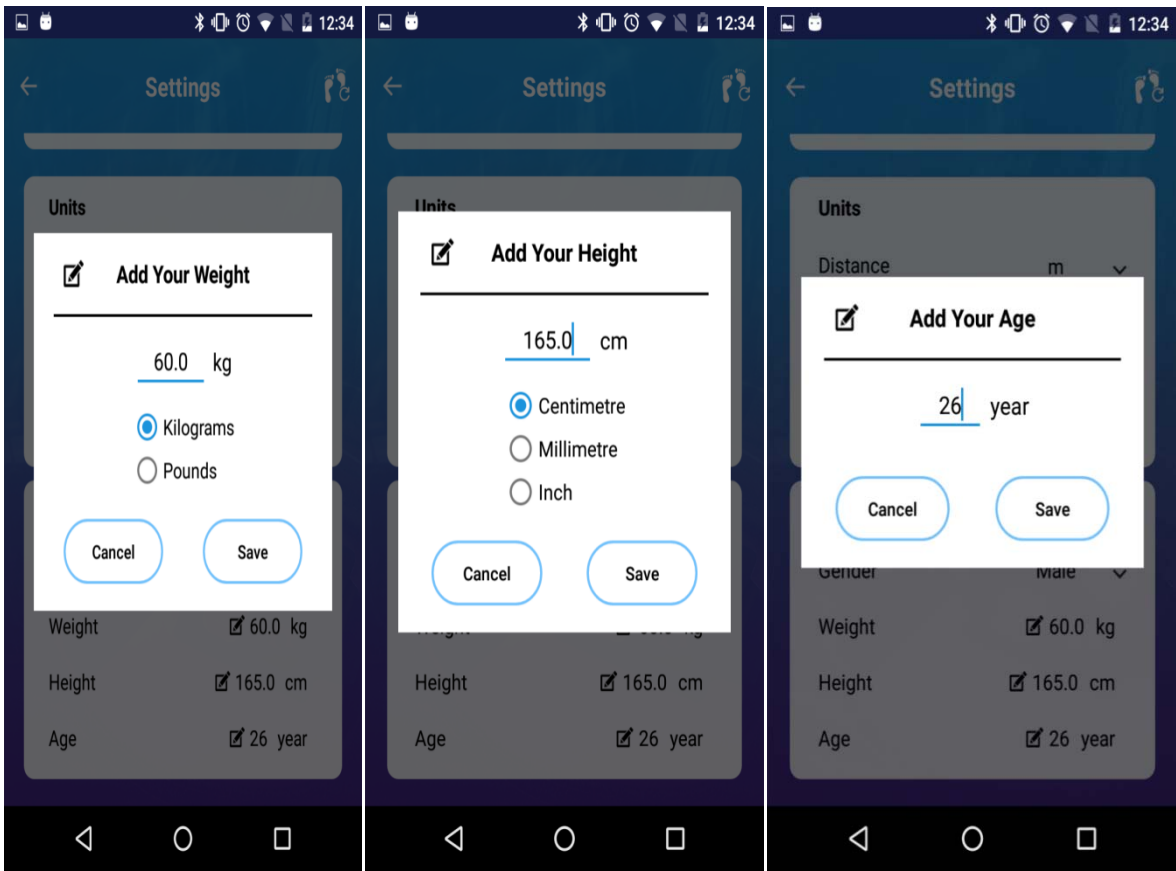

Figure43: Setting Personal Details like Weight, Height and Age

6.5 Low Battery Warning

When the Smart Watch reaches Low Battery (40%), the Smart Watch will send a message to the Application, if it is connected to the Smart Phone. A popup will be shown in the Application as in the **Fig. 42**.

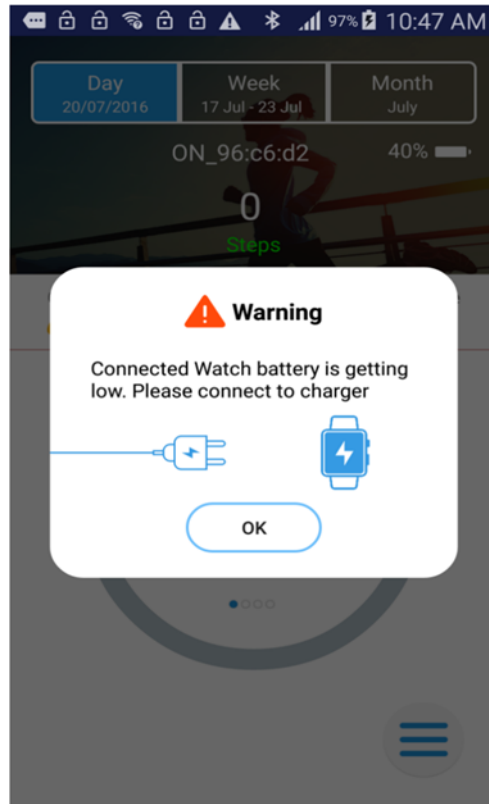

Figure44: Low BatteryPopup

6.6 Auto Reconnection

If the Smart Watch got disconnected from the Application due to some range problem, or disconnected from the Smart Watch side, then the Application will try to Auto Reconnect with the Smart Watch once it comes in range. The sequence of the screens is as shown in the **Fig. 43**.

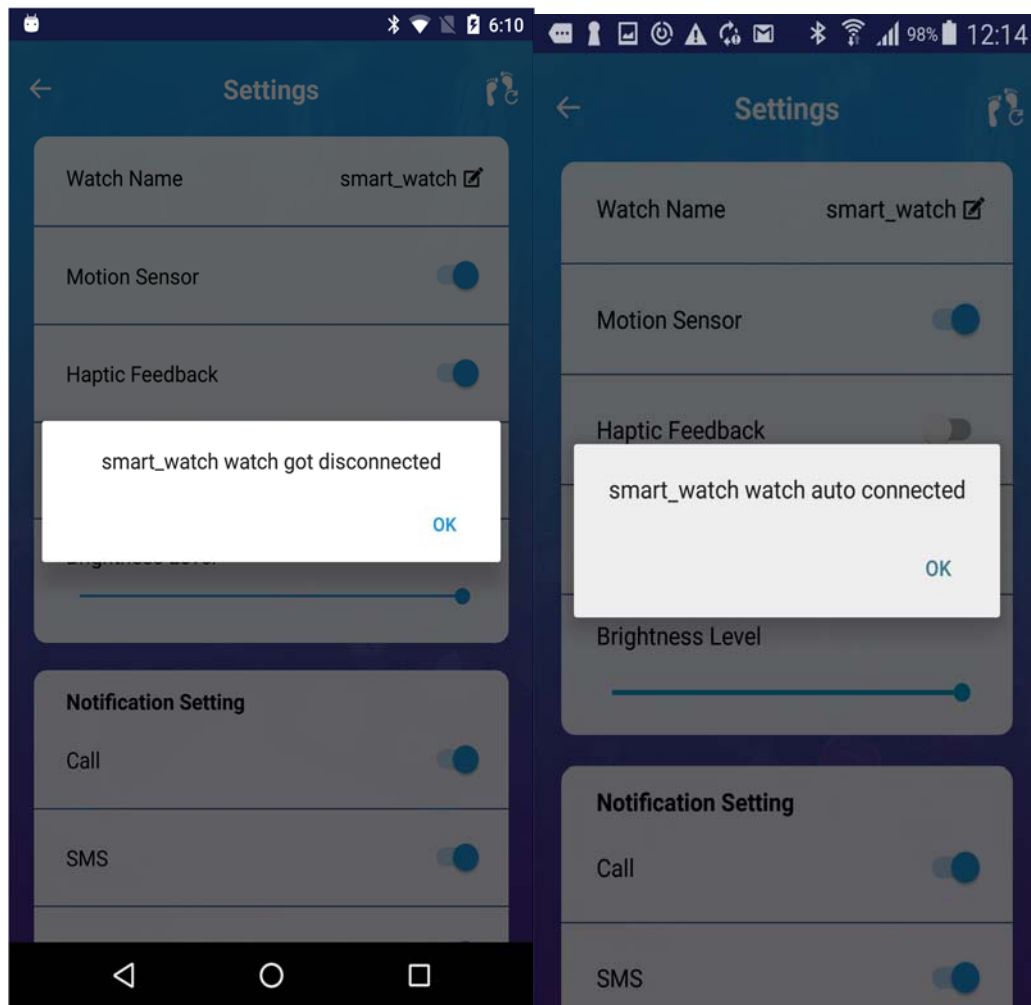

Figure45: Disconnecting and Auto Connecting

6.7 Searching for a Connection

When the Application starts running in the foreground after running in background, it will start searching for a Bluetooth Connection for 40 seconds, as shown in the **Fig 44**. If



Wearable Development Kit User Manual

the connection is available, the Application will connect to the Smart Watch, otherwise it will show an “Unable to Connect” message. Then User can scan for the device.

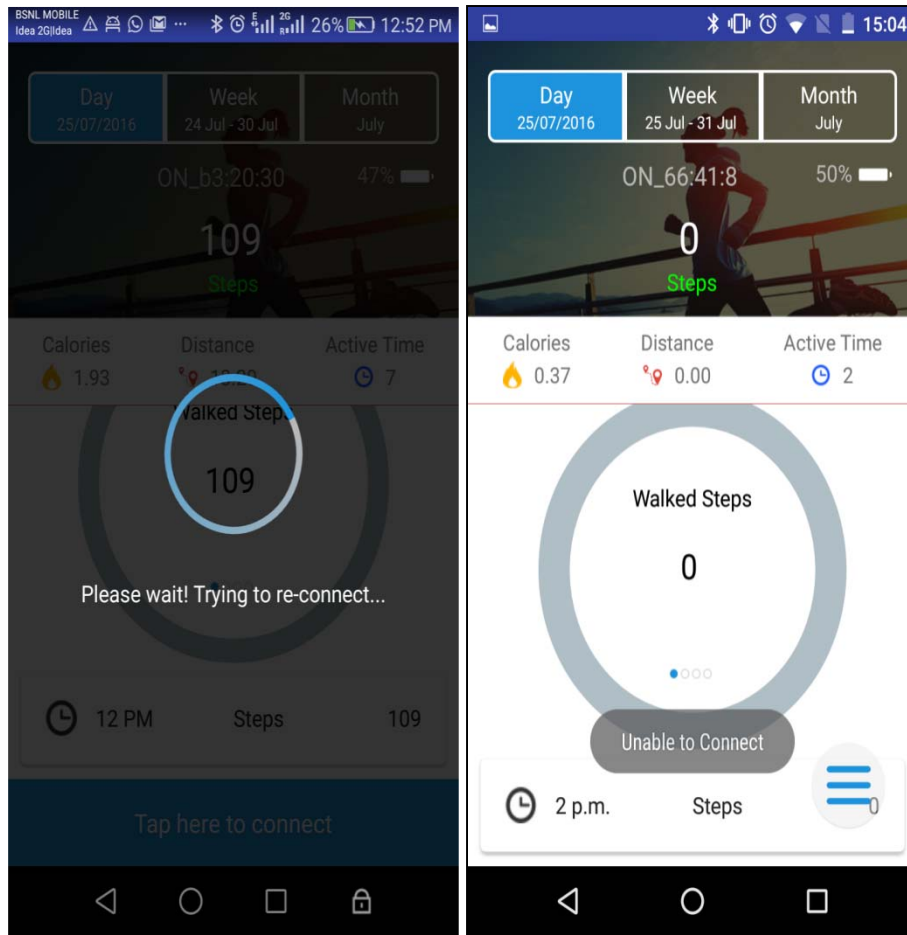

Figure46: Searching for the Bluetooth Connection



7 IOS Mobile Application

7.1 Supported Devices

The following devices are supported-

- iPhone with iOS Version 8 and above.

7.2 List of Features

Below is the sequence of screens, which will be loaded while using this Application.

7.2.1 Splash Screen

Splash Screen with the ON Semiconductor Smart Watch name and logo as shown in Figure45 will be displaying for 3 seconds.



Figure47: Splash screen



7.2.2 Enabling Permission for Notification

After the Splash Screen the following sequence of screens will be displayed, prompting the user to enable the Notifications Permission in phone as shown in **Fig 46**.

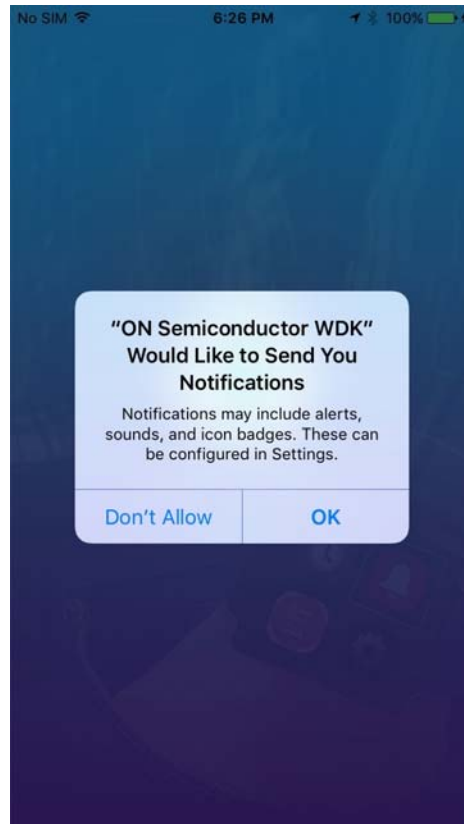

Figure48: EnableNotificationsPermission

7.2.3 Initial Smart Watch Connect Screen

- In this Smart Watch Connect Screen, User can scan for new a New Smart Watch by tapping on Watch Icon.
- On taping the Watch Icon it will be leading to the Guidelines Screen as shown.

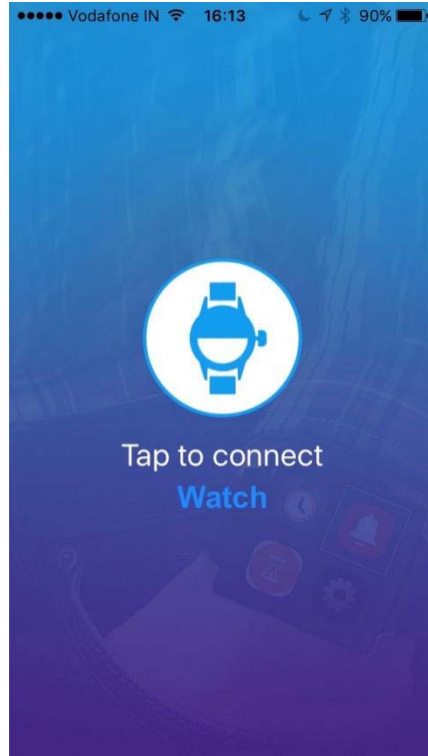

Figure49: Initial Smart Watch Connection Screens

7.2.4 Guideline Screen

The Guideline Screen will appear after tapping on the Watch Icon in Home Screen. This screen will contain various guidelines to user that will help user in pairing the Smart Watch with the Smart Phone. Tap on the Scan Button from the screen.

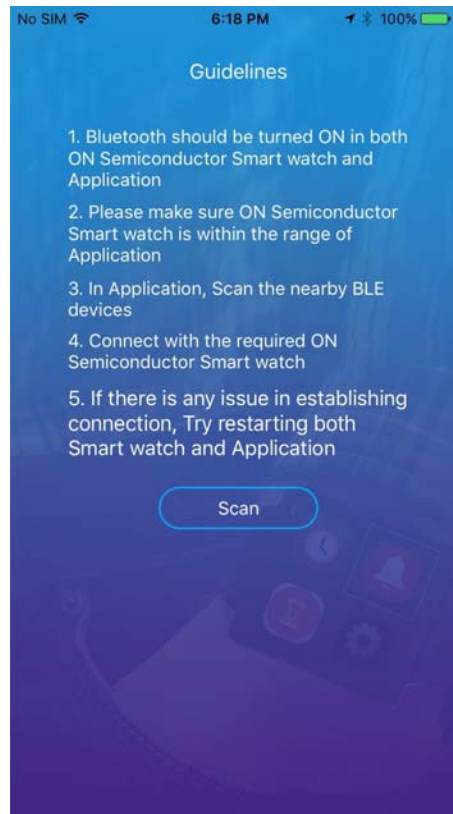

Figure50: Guidelines screen

7.2.5 Turning ON the Bluetooth Device

After tapping the Scan Button on Guidelines Screen, if Bluetooth is not already turned ON, then there will be a popup asking to turn on Bluetooth,

- Tap “Turn ON” option from the popup.
- Then it will start scanning for the nearby available devices.

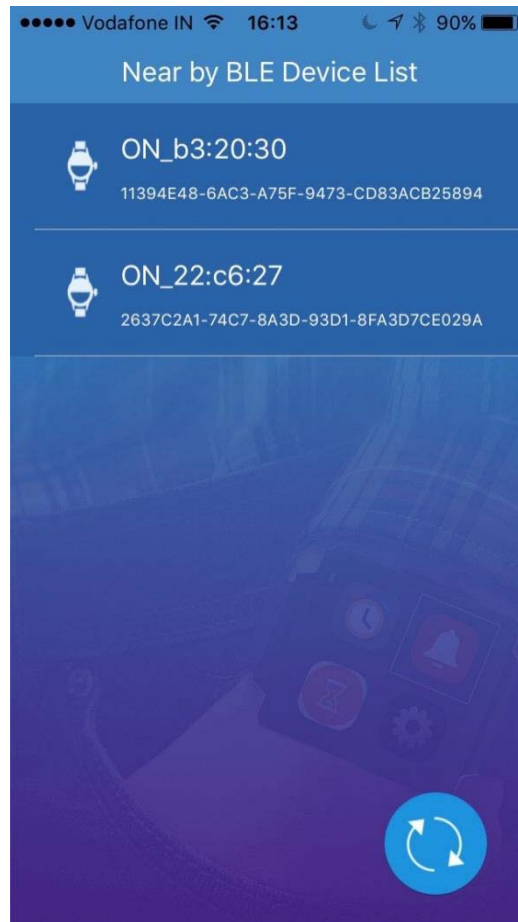

Figure51: Bluetooth ON Permission Popup

7.2.6 List of Nearby BLE Devices

The list of Nearby BLE Devices Screen will show the list of all nearby available BLE Devices. The Screen also contains a Refresh Icon. By tapping on Refresh Icon, it will refresh the list of the BLE Devices nearby.

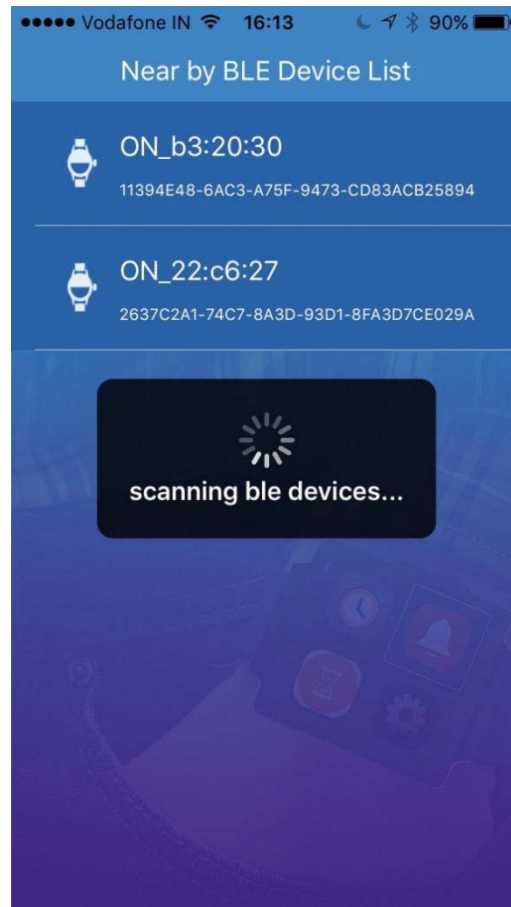

Figure52: Available Devices Name

- Tap on the Device Name to be connected. A popup will be shown in **Fig 51**
- There will be connection options Cancel and Connect. On tapping Connect option, user can establish connection with the Smart Watch.

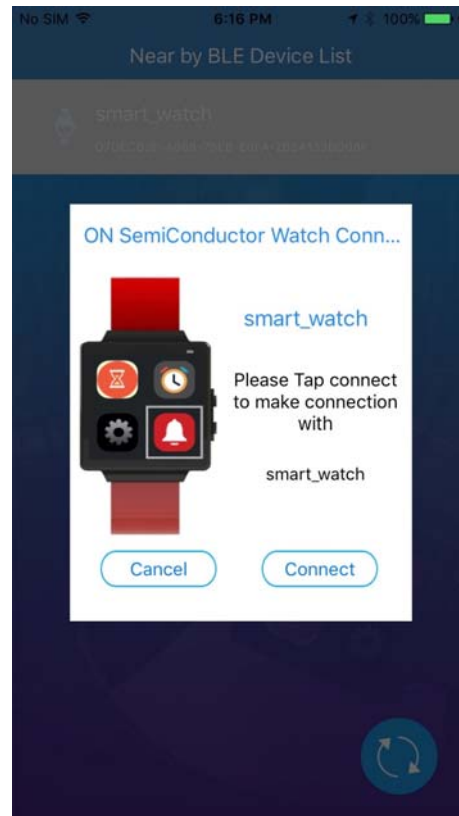

Figure53: Connect with the Selected Device

After successful connection between Smart Watch and Smart Phone, User will be directed to Home Screen (History Screen).

7.2.7 History Screen

After the establishment of connection, the History Screen will be shown as shown in the Figure. In the History Screen there are three views on the header. Day, Week and Month. On tapping on each view, respective details will be shown in the screen. There is a Progress Bar in the center; it shows the progress of the action. On sliding on the view inside the Progress Bar, Steps Walked, Distance Travelled, Calories Burned and Active Minutes will be shown. The name of connected Smart Watch and its battery percentage will be shown in the screen. If the watch is in disconnected state, the Smart Watch name and the battery percentage will be shown in a grey color, when connect it will be in white color. Fitness History is shown in the bottom of the screen by using the recycler view.

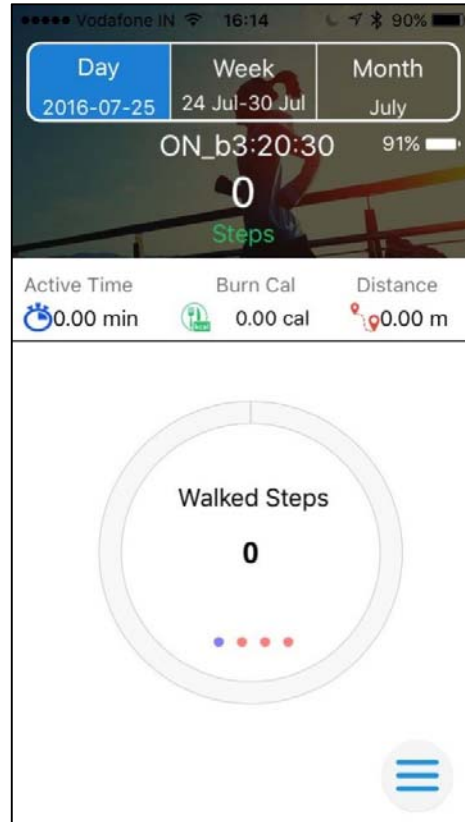

Figure54: Home Screen

7.2.7.1 Menu Screen

On tapping on the Floating Action Button the Menu Option will be showing.

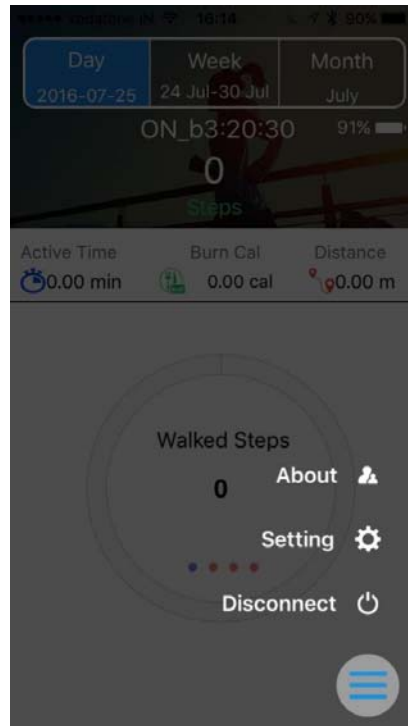

Figure55: Menu screen

Below options are available in Menu Screen.

- 1 Settings:** On tapping the Settings Button, the user will be redirected to the Setting Screen to change the settings of Application.

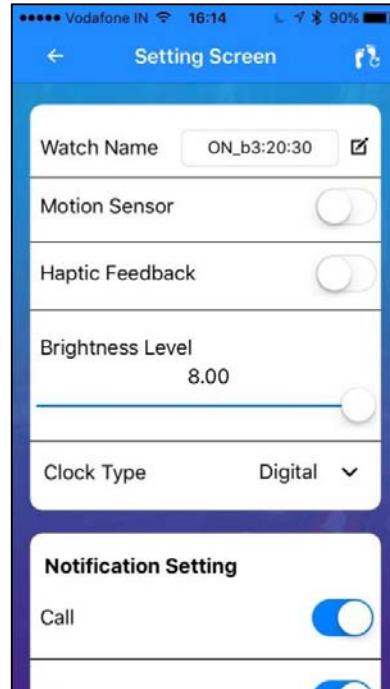

Figure56: Settings screen

- About Us:** On tapping the About Us from the menu option, the user will be redirected to About Us Screen. The current version of Smart Phone Application and Smart Watch firmware version is shown in the About Us Screen.

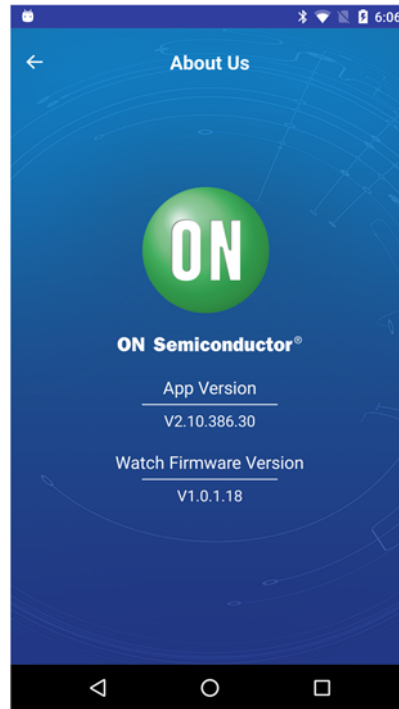

Figure57: About Us Screen

- 3 Disconnect:** User can manually disconnect the application from the Smart Watch by tapping the Disconnect option from the menu. Upon tapping, a popup will be shown as follows.

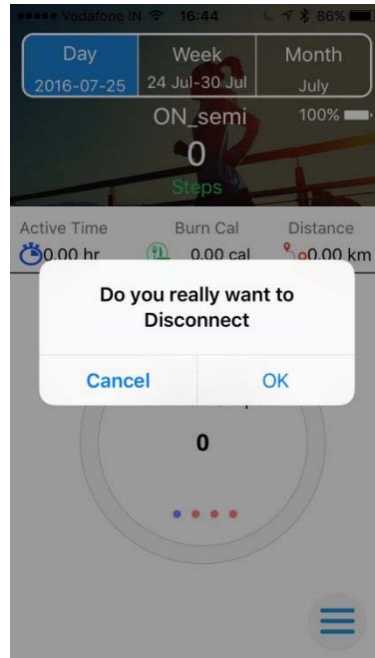

Figure58: Permission for disconnecting

Upon tapping the OK Button, the Application will disconnect from the Smart Watch. The Disconnect Screen will look like as follows.

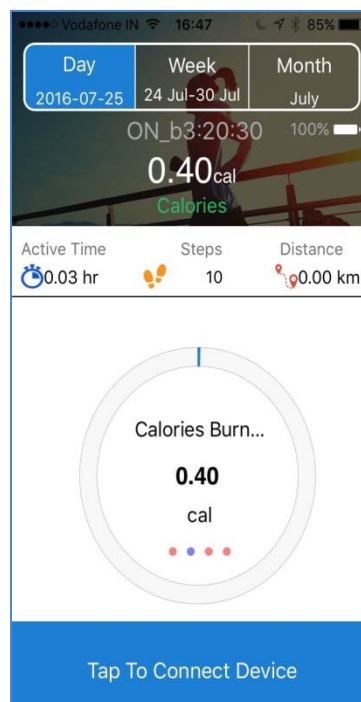

Figure59: Disconnect screen

7.3 Configuration Settings

From the Settings Screen the following features can be controlled.

7.3.1 Smart Watch Name

User can edit the Smart Watch Name from the Smart Phone Application, when the Smart Watch and Application are in connection. A popup will be shown on tapping the Edit Watch Name View as shown in the **Fig 58**. A new name can be given there. The Smart Watch will display the new name. The name size is limited by characters.

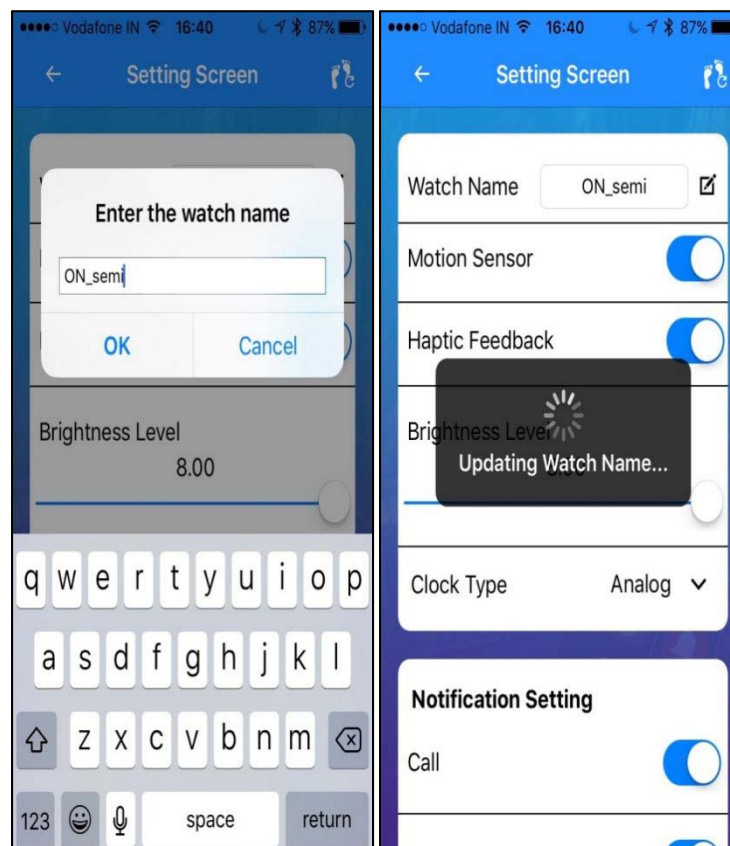

Figure60: Edit the watch name

7.3.2 Motion Sensor

Once the Motion Sensor is turned ON from the Application, the Smart Watch will start sending the Steps Count every fifth second. While enabling or disabling the Motion Sensor, pop-ups will be shown. Sequences of popup screens are shown below

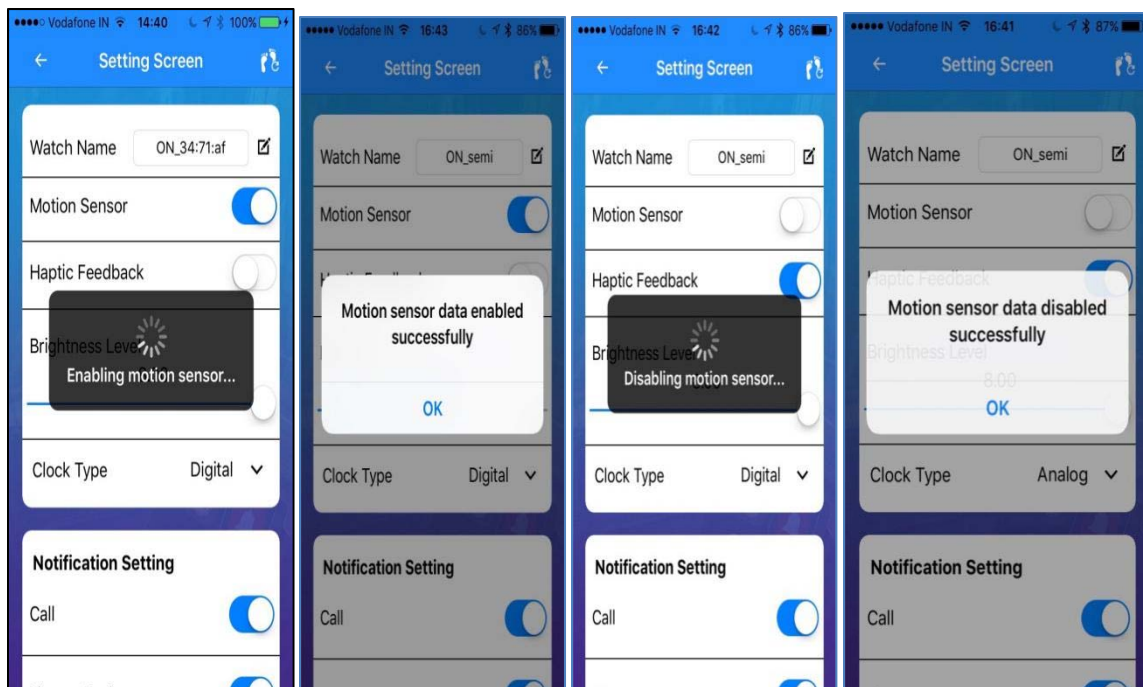

Figure61: Motion Sensor-Enable-Disable

Note: Resetting the Data

- There is an option for resetting the data in the database. There is a Reset Button on the top right corner in the Settings Screen as shown in the figure below.

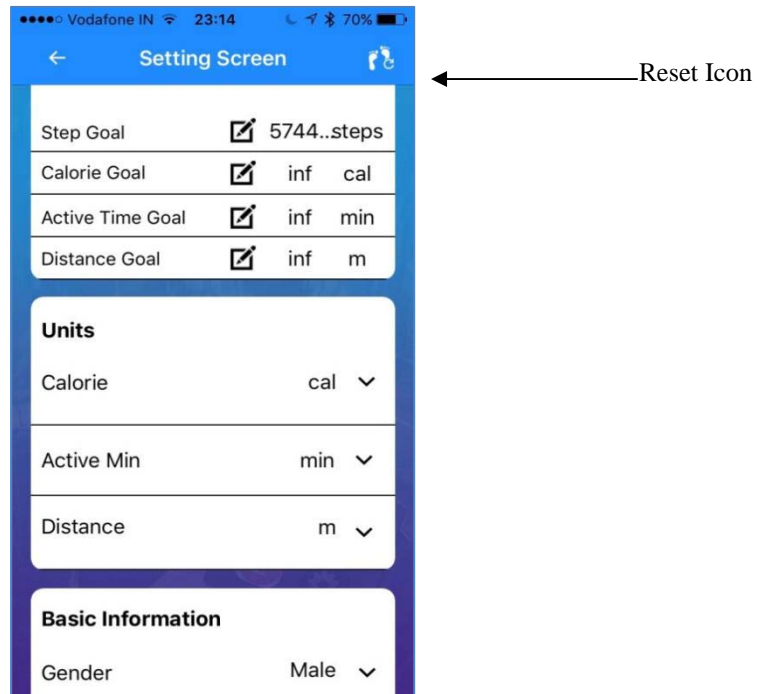

Figure62: Reset button

- On tapping on the Reset Button, the previous data stored in the database will be reset.

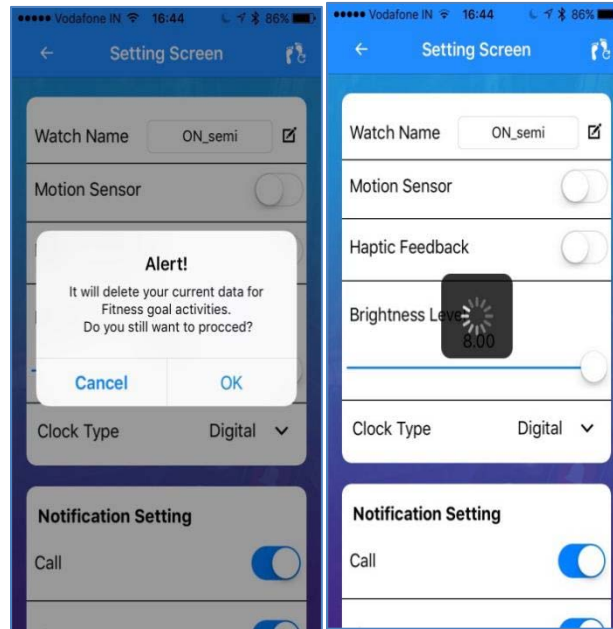

Figure63: Resetting the data

7.3.3 Haptic Feedback

Haptic Feedback can be turned ON from the Application. Once the Haptic Feedback is ON, the Smart Watch will receive Haptic Feedback (vibration) for every notification received from Smart Phone. A popup will be shown when Haptic Feedback is Enabled or Disabled.

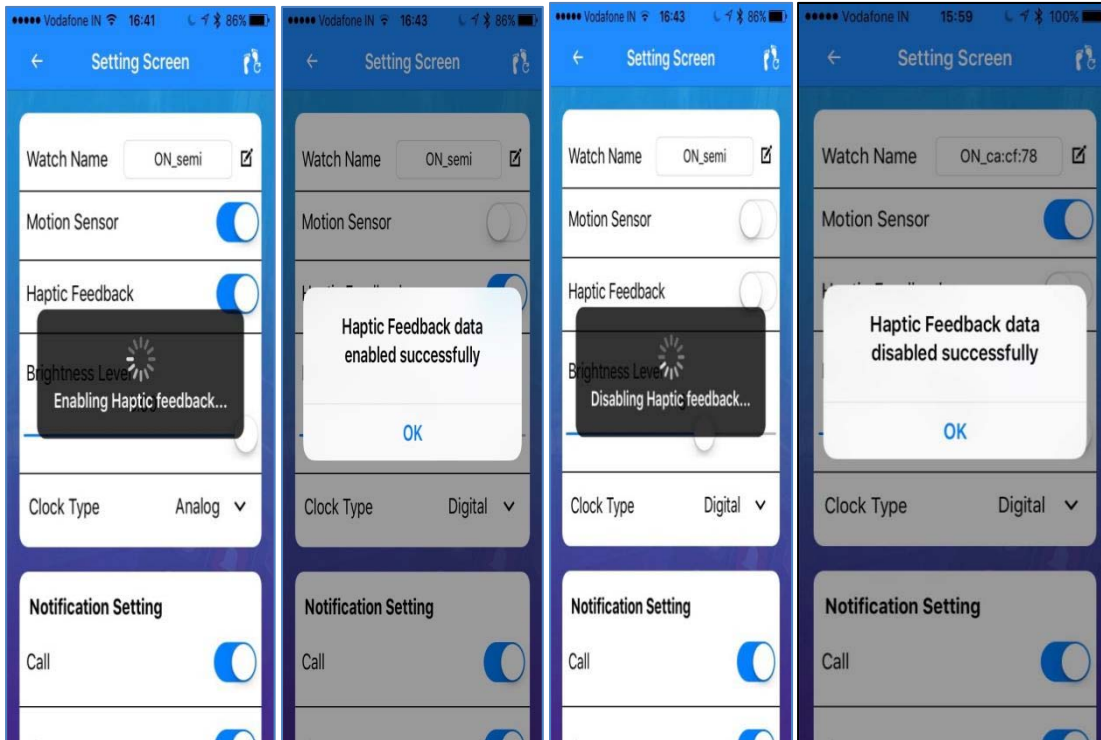

Figure64: Haptic Feedback-Enable-Disable

7.3.4 Clock type

User can choose the clock type from the drop down box.

1. Digital
2. Analog

Once User chooses the Analog from the drop down, the Smart Watch will set the clock type as Analog and vice versa as shown in the figure below.

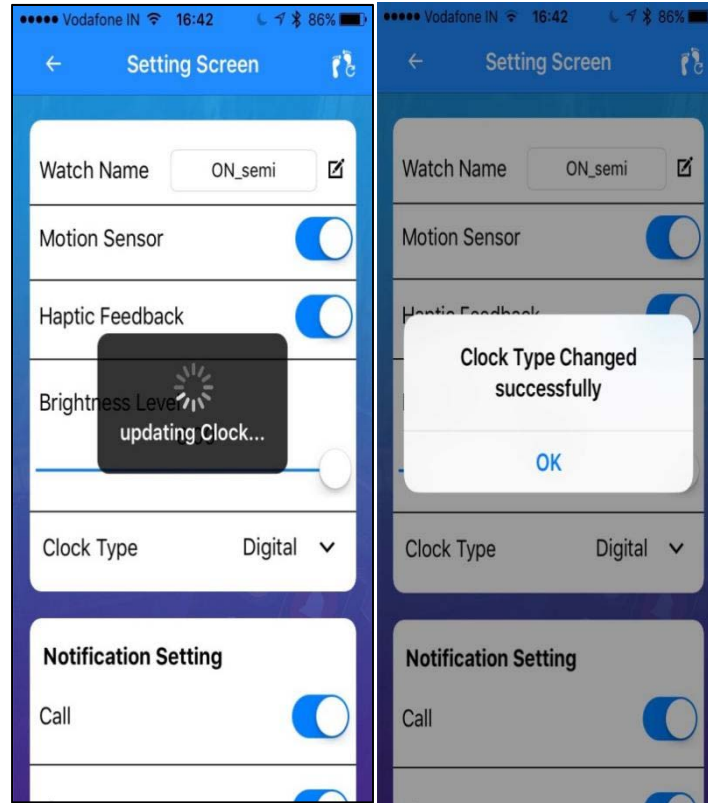

Figure65: Clock type

7.3.5 Brightness Level

User can adjust the Brightness Level of the Smart Watch Screen from the ON Semiconductor Application by touch on the Seek Bar in the Settings Screen. If the brightness updating is successful, popup will be shown as below

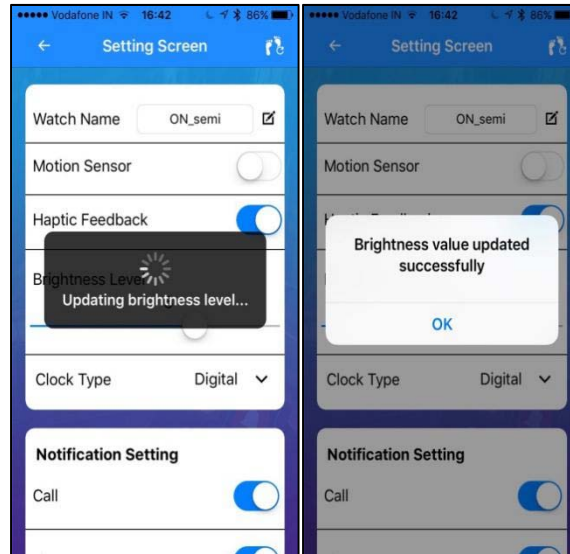

Figure66: Brightness Control

7.3.6 Notification Settings

From the Settings Menu, we can Enable or Disable the notifications to the Smart Watch.

Below are the notifications supported in iOS

1. Call Notification

2. Fitness Notification.

- If the notification is enabled, corresponding notifications will be sent to the Smart Watch.
- User has the option to set the Fitness Goal for the day in the Settings Screen. Once the goal is reached, a notification will be sent to the Smart Watch.

The Setting Screen for Enabling Notification and Fitness Set Up are as shown in the figure below.

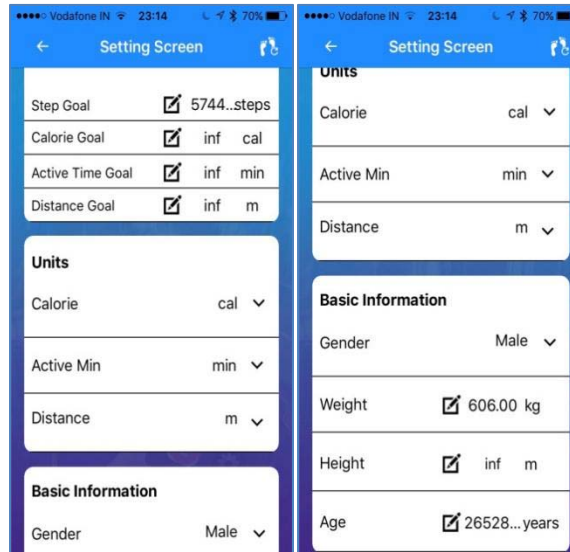

Figure67: Notification and Fitness Settings Screen

User can set the Fitness Goal for the day. If no fitness values are set, the application will set default value as the goal. Once the goal is reached (set value) the smart application will notify the Smart Watch. There are also options to fill User Information like Height, Weight, and Age which are necessary to calculate the parameters.

7.3.7 Goal Settings

User can set a goal to be achieved for the day. There are options to set the goal for Steps, Calories to be Burned, Active Time (working out time), and Distance to be Covered. Upon clicking each option, a popup will be shown. User can set the goal value. The popup screens are shown in the figure below.

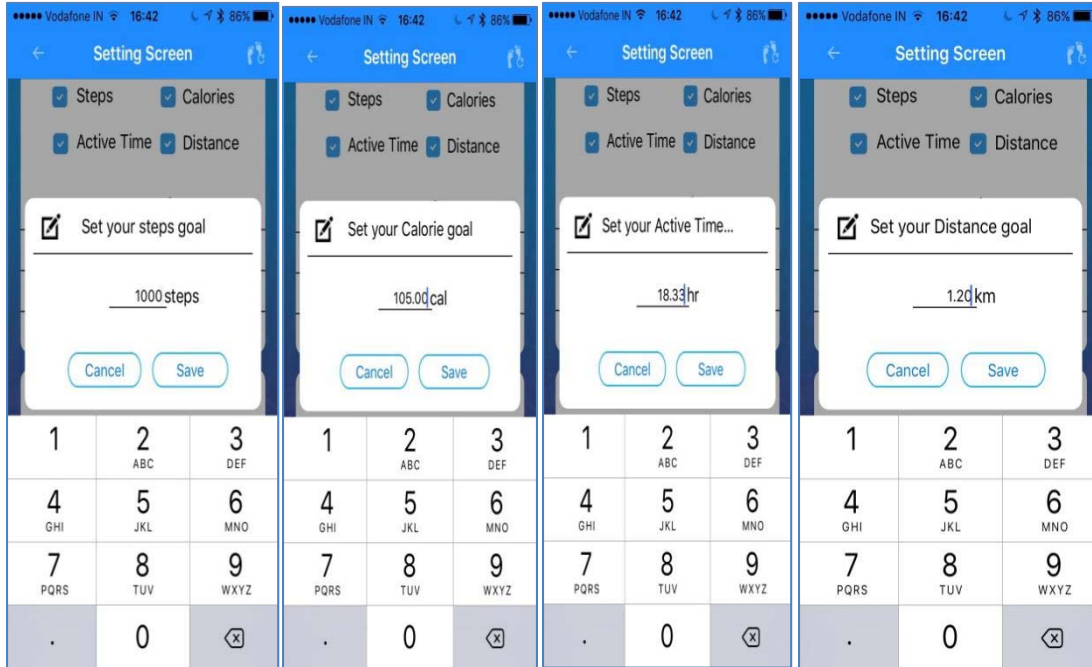

Figure68: Setting Goal Value for Steps, Calories, Active Time and Distance

The Goal Notification Screens are as shown in Fig. 67.

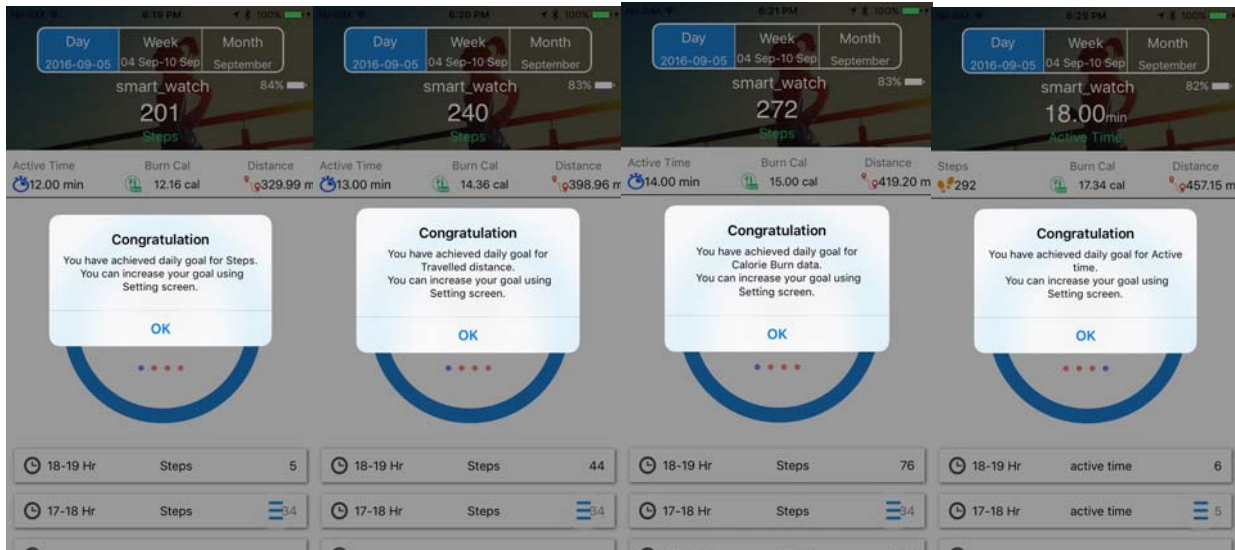

Figure69: Goal Achievement



7.3.8 General Information About User

User can provide the information about Gender, Height, Weight, and Age in the space given. Upon clicking each option, a popup will be shown. User can enter the details and save it. The details will be saved in the local data base.

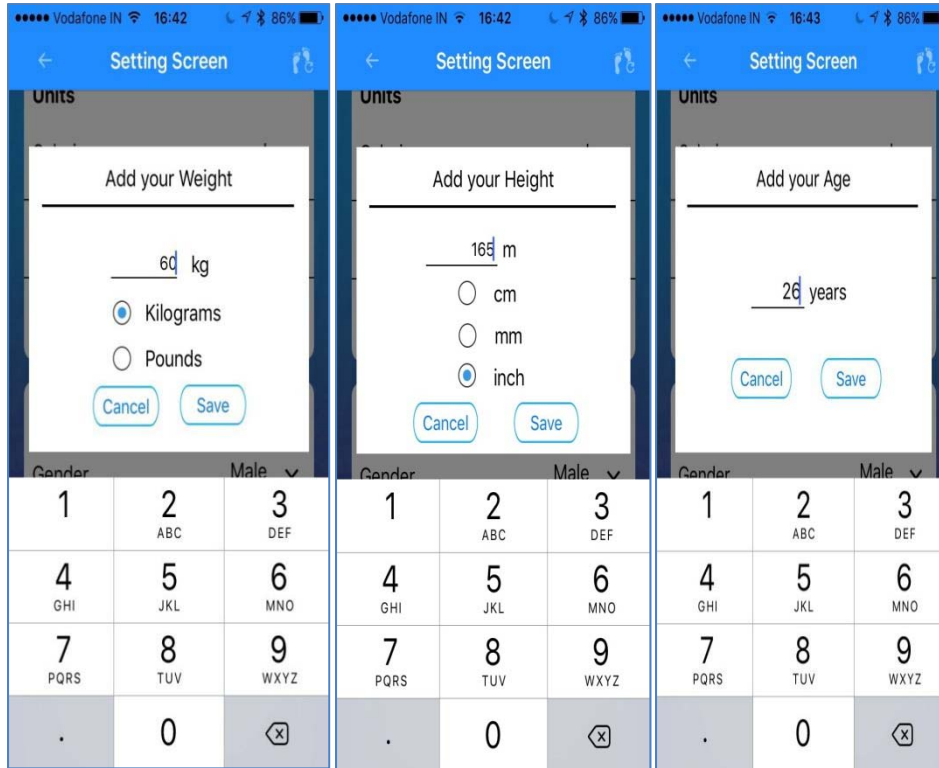

Figure 70: Setting Personal Details like Weight, Height and Age

7.4 Low Battery Warning

When the Smart Watch reaches 40% of Battery Level, a Low Battery Warning will be received from Smart Watch, if it is in connected state. The below popup will be shown

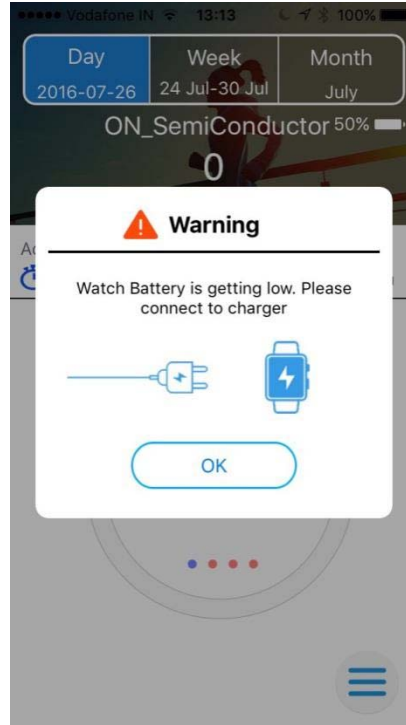

Figure 71: Low Battery Popup

7.5 Auto Reconnection

If the Smart Watch is disconnected from the application due to some range problem, or disconnected from the Smart Watch side, then the Application will try to Auto Reconnect with the Smart Watch once it comes in range. Below is the sequence of screens -

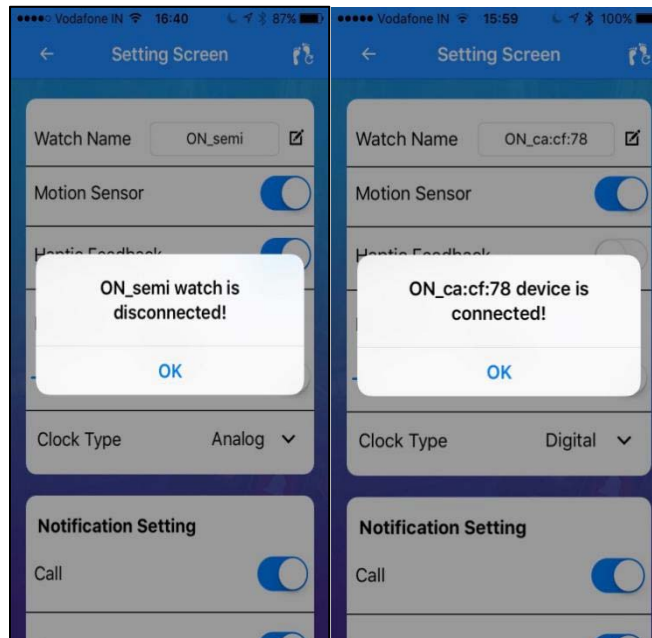

Figure72: Disconnecting and Auto Connecting